

# Engineered wood panels

Product range

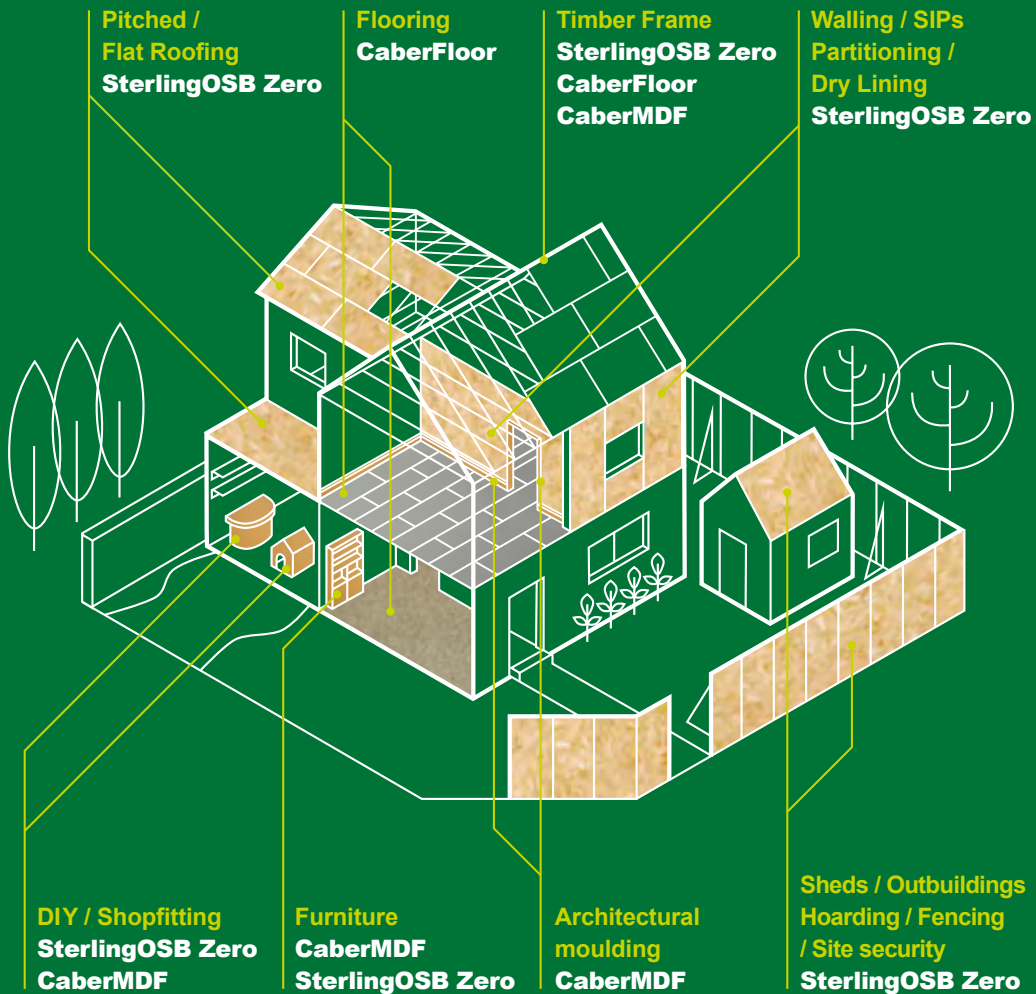

# PANEL PRODUCTS FOR EVERY APPLICATION



## INTERACTIVE PDF.

Quickly navigate to a desired section by clicking on the page base controls and side tabs.

## INDEX

- 04. Introduction
- 10. SterlingOSB Zero - an overview
- 14. CaberFloor - an overview
- 22. CaberMDF - an overview
- 28. Product application guide
- 30. Roofing
- 34. Flooring
- 44. Walling / SIPs / Partitioning / Dry Lining
- 48. Timber frames
- 52. Security
- 56. Shopfitting
- 60. Furniture
- 64. Other - Moulding and packaging
- 68. Technical information
- 102. Environmental credentials
- 104. Customer support



**EXCELLENT  
SERVICE  
LEVELS**



**LOW CARBON  
FOOTPRINT**  
as all our products  
are made in the UK



**REPUTATION  
FOR DELIVERING  
ON TIME**



**CONSISTENT  
QUALITY**



**INTERACTIVE BROCHURE.**

Quickly navigate to a desired section by clicking on the page base controls and side tabs.



<< PREVIOUS PAGE



INDEX





As you'd expect from the UK's No 1 producer of engineered wood panels, we are committed to playing our part in reducing our emissions, and we are greener than you might think. But being carbon neutral wasn't enough for us, we wanted more, we wanted to be **carbon negative**.

We have been independently audited by Wood and independently verified and certified by the international EPD system Secretariat in Sweden and are proud that West Fraser's European products have been certified as being net carbon negative. This means we lock up more CO<sub>2</sub>e in our products than we emit making them. **FACT.**

**UK Gov net zero**  
 Carbon Dioxide (known as CO<sub>2</sub>) is a greenhouse gas that is produced by almost everything humans do, and it increases the amount of heat that is trapped in the atmosphere, one of the major causes of climate change. The world is finally taking notice and the UK has pledged to be carbon neutral by 2050.

## Carbon negative. How we've done it.



Our products lock in 1.1 million tonnes of CO<sub>2</sub>e every year

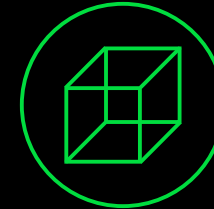

For every 1m<sup>3</sup> of OSB we make in the UK, 828kg of CO<sub>2</sub>e is sequestered



74% of our primary energy use is from renewable sources



All West Fraser's UK manufacturing sites are certified to the coveted environmental criteria of ISO14001



99.5% of all raw material is used, with less than half a percent being wasted



All our products are FSC® certified and can 100% be recycled



Low energy LED lighting, with motion sensors, is being installed across our sites



We've reduced our air miles by 19% from 2017-2019



Our fleet of diesel company cars is being replaced with hybrid vehicles

## Carbon negative. Positive future.

## THE #1 CHOICE

As one of the world's leading manufacturers of engineered wood-based panel products, we are regularly seen as the No.1 choice in the construction, DIY, and furniture sectors.

This has allowed us to become one of the most trusted and respected suppliers to the trade, with a wide range of panel products to suit a multitude of jobs and applications.

We are proud that our UK-made products are all certified net carbon negative, meaning we remove more carbon than we emit. Our engineered wood panel products help the UK construction comply with net zero targets. Use our net carbon negative products to offset building emissions.



### **SterlingOSB® Zero** Strength you can build on

Strong, consistent and great value, the SterlingOSB Zero range is ideal for structural applications.

- SterlingOSB Zero OSB3
- SterlingOSB Zero T&G
- SterlingOSB Zero PrimedPlus

### **CaberFloor®** Systems you can trust

Versatile flooring system for domestic and commercial floors, CaberFloor is stable, durable and easy to lay.

- CaberFloor P5
- CaberDek
- CaberShieldPlus
- CaberAcoustic
- CaberFix D4 (Adhesive)
- CaberFix D3 (Adhesive)
- CaberFix Joint&Joist (Adhesive)
- CaberFix Tape
- CaberFix X-Treme Tape

### **CaberMDF®** The professional's range

Engineered with consistent density for multiple use throughout the shop fitting, construction and furniture industries.

- CaberMDF Trade
- CaberMDF Trade MR
- CaberMDF Pro
- CaberMDF Pro MR
- CaberMDF Industrial

# SterlingOSB® Zero®

## Strength you can build on

Stronger and tougher than ply with no knots, voids or de-lamination, the SterlingOSB Zero range is great value and ideal for structural applications.

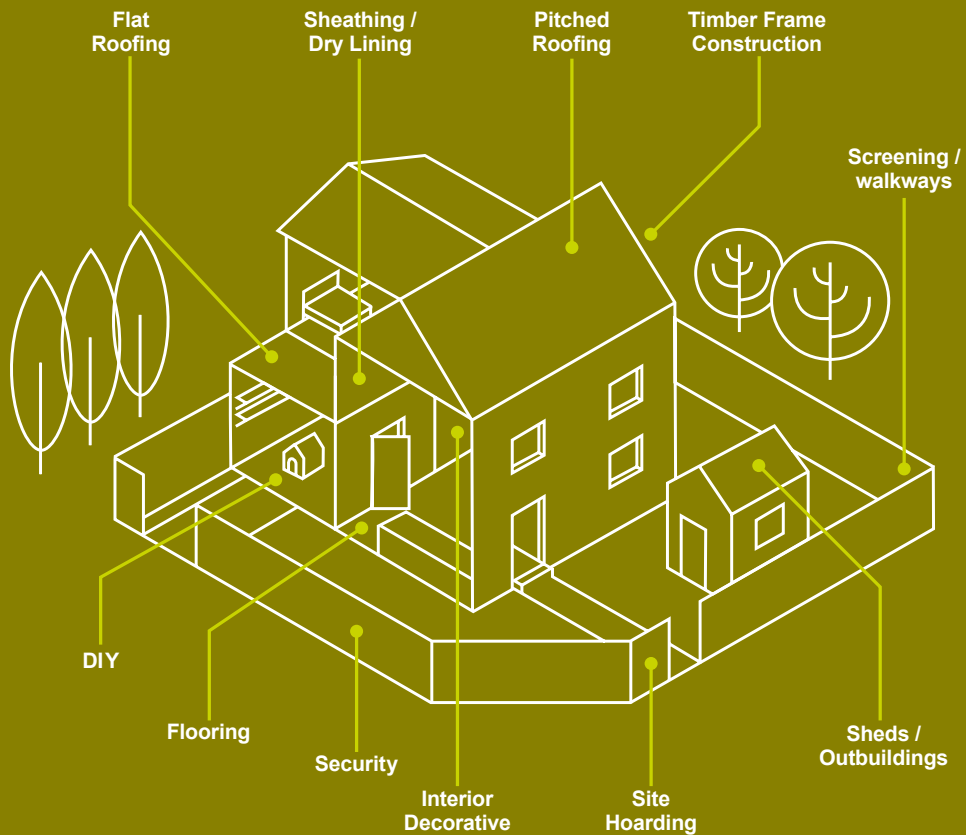

### SterlingOSB® Zero® OSB3

For structural use in dry or humid load bearing conditions

### SterlingOSB® Zero® T&G

T&G profile strengthens connecting panels for roofing and flooring

### SterlingOSB® Zero® PrimedPlus

Pre-painted with a UV coating and sealed edges ready for immediate use or the application of graphics



A versatile range, designed for purpose

## SterlingOSB® Zero OSB3

Highly versatile board for structural use in load bearing dry or humid conditions.

- Uniform, high quality panels
- No knots, voids or de-laminating problems
- Stronger and tougher than most softwood plywood
- Easy to work with
- Nails can be driven as close as 8mm from panel edge without splitting
- Can be finished with most popular surface treatments
- The first and only UK made OSB with zero-added formaldehyde

## SterlingOSB® Zero T&G

Tongue and groove board with a smooth surface finish, for roofing and flooring.

- T&G profile helps elongate lifespan of boards by reducing movement
- Fully BBA approved
- Machined to exact tolerances
- Smooth surface designed to offer excellent finish with most surface treatments
- No knots, voids or de-laminating problems
- Stronger and tougher than most softwood plywood

Recommended product

Application*	SterlingOSB Zero OSB3	SterlingOSB Zero T&G	SterlingOSB PrimedPlus
Use in dry conditions	DIY projects	•	•
	Garden sheds	•	
	Packaging and pallets	•	
	Shelving / boxing in	•	•
	Internal hoarding	•	•
	Exhibition displays	•	•
	Built-in furniture	•	•
	Interior decorative	•	•
Use in humid conditions	Site hoardings	•	•
	Agricultural buildings	•	•
	Caravans	•	•
	Portable buildings	•	•
	Flooring	•	•
	Wall sheathing	•	
	Flat and pitched roofs	•	•
	Timber frame	•	•
	Dry lining		

\*The above table provides general guidance only. It is recommended that you conduct small scale pilot tests to ensure you have the correct grade for your end use.

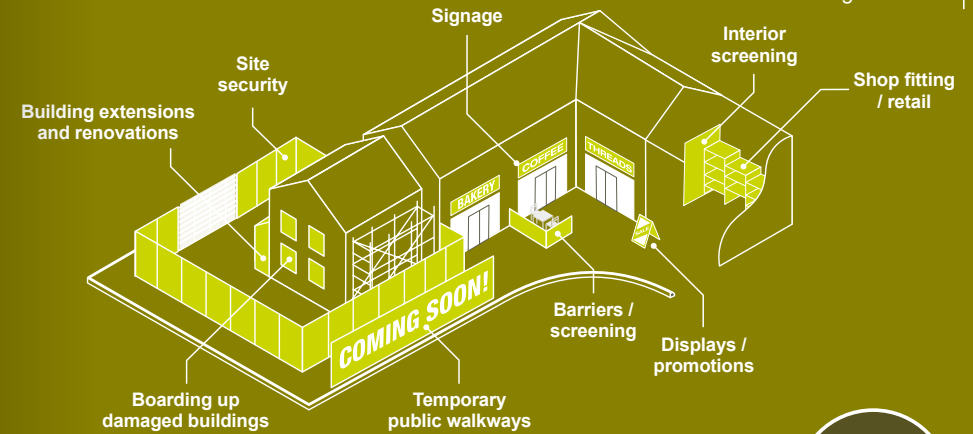

## SterlingOSB® Zero PrimedPlus



Pre-painted with a UV coating and sealed edges ready for immediate use or the application of graphics

- Pre-painted with a high quality cross-linked epoxy acylate UV cured coating on one side
- Sealed with a unique wax impregnated hydroscopic edge treatment
- Available in white or grey
- A blank canvas for marketing messages
- Can be used inside and out immediately
- Designed for use with promotions and events, exhibition stands, the hospitality sector, as screening, as walkways, as site hoardings
- All the inherent benefits of SterlingOSB Zero

Product	Thickness mm	Length mm	Width mm	Edge profile	Sheets per pack
SterlingOSB Zero OSB3	9, 11, 15, 18	2400	1200	SE	100, 84, 60, 50
	9, 11, 15, 18	2440	1220	SE	100, 84, 60, 50
	9	2700	1200	SE	100
SterlingOSB Zero T&G	18, 22*	2400	1200	TG2	50, 41
	18, 22*	2440	1200	TG2	50, 41
	18	2400	590	TG4	100
SterlingOSB Zero PrimedPlus	18	2440	1220	SE	50

SterlingOSB Zero conforms with



The mark of responsible forestry



# CaberFloor®

## Systems you can trust

An advanced range of flooring products designed to fit all applications; new-build, replacement, domestic and commercial.

### CaberFloor P5®

The UK's most specified moisture resistant P5. Stable, durable and easy to lay, it's not difficult to see why.

### CaberShield+®

An advanced product with a permanent waterproof coating on both sides for flooring when the roof's off.

### CaberFix®

A range of powerful sealing and fixing systems specifically developed for CaberFloor flooring.

### CaberDek®

P5 with a strong, waterproof and slip-resistant peelable film, that when removed leaves a clean finished floor.

### CaberAcoustic®

P5 flooring panel designed to reduce both impact and airborne transmitted sounds.

## What's best for you?

A guide to choosing the most suitable flooring system

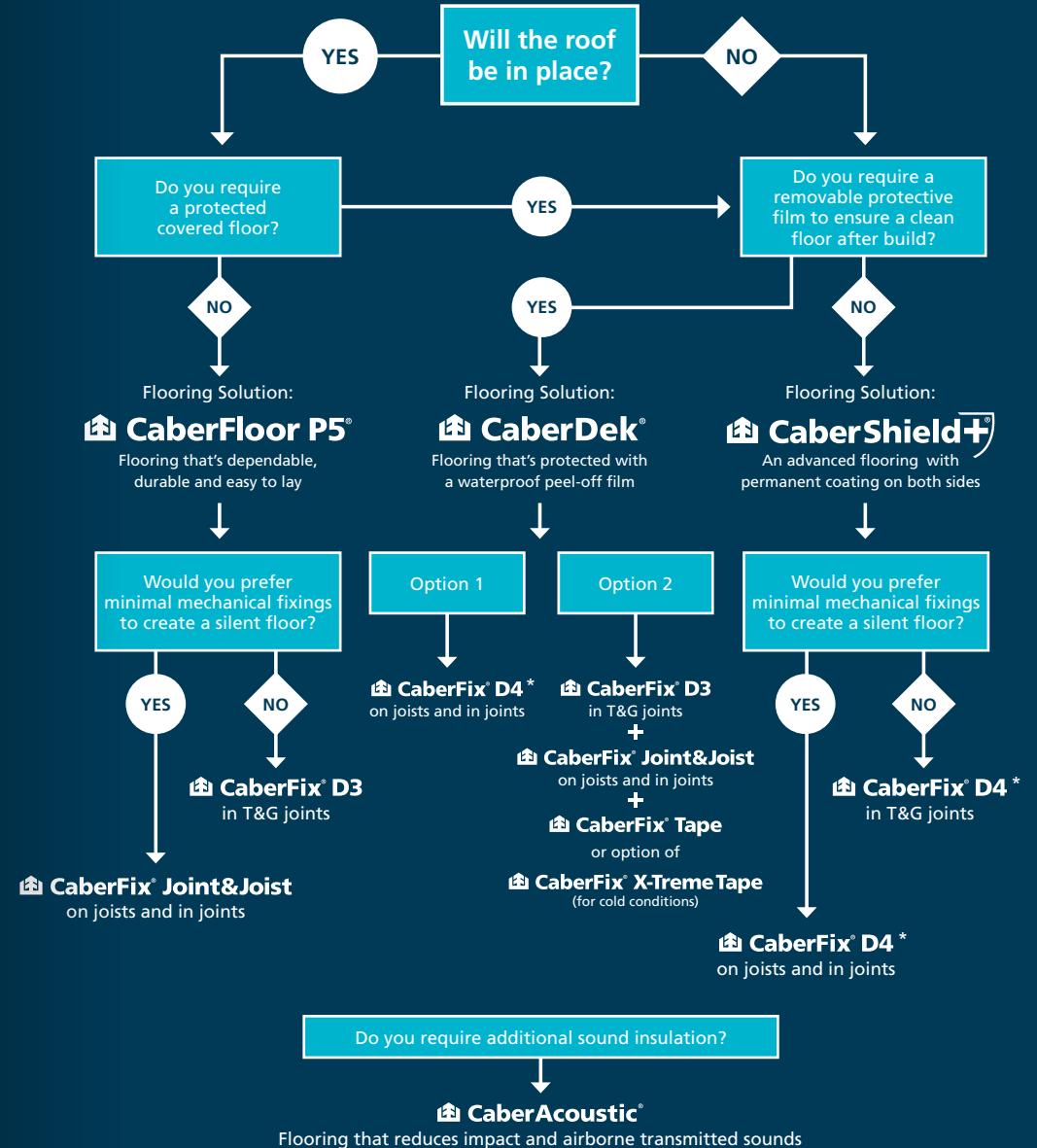

\*Important information about CaberFix D4. All professionals and industrial users must complete training before using products containing more than 0.1% of monomeric diisocyanates - visit <https://uk.westfraser.com/safe-handling-training-for-pu-adhesives/> for details and training



CaberDek's factory-installed removable protective film ensures installation is quick and the final floor is clean after the build.



## Flooring solutions

### CaberFloor P5®

High-strength P5 wood particleboard for domestic and most other floors.

- Tongue and groove or square-edged profile
- Stable, durable, easy to lay
- Moisture-resistant
- Provides an excellent surface for subsequent floor laying operations
- Removes the need for intermediate noggins
- Strong and robust

#### Recommended product

	CaberFloor P5	CaberFloor P5	CaberDek	CaberDek	CaberShieldPlus	CaberAcoustic	CaberAcoustic
<b>Thickness (mm)</b>	18	22	18	22	22	28	32
<b>Dry Domestic</b>	•	•	•	•	•	•	•
<b>Domestic new build</b>	•	•	•	•	•	•	•
<b>Refurbishment</b>	•	•	•	•	•	•	•
<b>Commercial</b>		•		•	•		•

\*The above table provides general guidance only. It is recommended that you conduct small scale pilot tests to ensure you have the correct grade for your end use.

### CaberDek®

P5 grade flooring protected from the elements and construction mess.

- Incorporates a strong waterproof and slip-resistant peelable film
- Impact, puncture and tear resistant film withstands high site traffic
- 44dB sound reduction when used in conjunction with leading I-beam and insulation manufacturers
- BBA approved for 42 days exposure\* when installed with CaberFix
- Complies with BS EN312: part 5

\*When installed according to manufacturer's instructions

### CaberShield+™

An advanced product designed to keep you building in all weathers.

- Double-sided protection with a tough, permanent waterproof coating
- BBA approved for 60 days exposure\* when used with CaberFix D4 adhesive
- Non-slip, safe working platform that withstands high site traffic
- Easy to slide into place with smooth underside
- Colour coded sides to make it easy to identify top surface
- All the inherent benefits of CaberFloor P5

### CaberAcoustic®

CaberFloor P5 particleboard with an acoustic layer to reduce sound transmission.

- Available as 18 or 22mm CaberFloor P5 with a 10mm sound reducing layer
- Reduces impact sounds transmission by  $\Delta L_w$  19dB†
- Contributes to airborne noise reduction††
- Made in the UK using eco recycled felt
- All the inherent benefits of CaberFloor P5

† 19dB sound reduction applies when CaberAcoustic is installed on its own. Greater reductions applicable when used within a system for noise transference reduction (see website for details).

†† When used in the right system.

Product	Thickness mm	Length mm	Width mm	Edge profile	Sheets per pack
<b>CaberFloor P5</b>	18, 22	2400	600	TG4	100, 82
<b>CaberDek</b>	18, 22	2400	600	TG4	100, 82
<b>CaberShieldPlus</b>	22	2400	600	TG4	82
<b>CaberAcoustic</b>	28†	2400	600	TG4	100
	32†	2400	600	TG4	82

Other grades and thicknesses of particleboard also available – please ask for details

† Including 10mm acoustic layer

NEXT PAGE >>

# CaberFix®

## Adhesives and tapes

A range of adhesives and tapes specifically developed for use with CaberFloor flooring.

### CaberFix® D4

A one-bottle adhesive and sealing solution that provides BBA approval when used to install CaberDek and CaberShieldPlus.

### CaberFix® Joint&Joist

A fast-setting hybrid polymer adhesive that provides a silent, flexible waterproof bond in CaberFloor flooring.

### CaberFix® X-Treme Tape

A highly durable, acrylic tape specifically for installing CaberDek in harsh winter conditions.

### CaberFix® D3

A powerful, fast-setting D3 PVA glue designed for sealing and fixing tongue and groove flooring.

### CaberFix® Tape

A polyethylene-coated cloth tape for sealing CaberDek perimeters to walls and sealing joints.

\*When installed according to manufacturer's instructions



CaberShieldPlus and CaberFix D4 flooring system meets BBA approval for up to 60 days exposure.\*

## Adhesives and sealing solutions

### CaberFix® D4

A one-bottle adhesive and sealing solution that provides BBA approval\* on CaberDek and CaberShieldPlus.

- Bonds T&G joints, flooring to joists, and seals exposed perimeter and edges
- Full BBA approval for up to 60 days exposure when installed according to manufacturer's instructions
- Solvent-free, one-component polyurethane adhesive
- Foaming adhesive can be seen in the joints making sure a seal is made
- Easy to use, easy to hold 1kg bottle with easy flow nozzle
- Meets BS EN 204

### CaberFix® Joint&Joist

A fast-setting, strong hybrid polymer adhesive designed for use with CaberFloor flooring.

- Provides a strong, silent bonding layer between floor and joists
- Creates a waterproof bond in T&G joints
- Bonds in damp conditions to a variety of materials
- Fast-setting and easy to use
- Strong and flexible bond with good gap-filling properties

\*When installed according to manufacturer's instructions

### CaberFix® D3

Powerful, water resistant D3 glue designed for sealing and fixing tongue and groove flooring.

- Fast-setting, it forms a strong, hard and rigid glue line
- D3 PVA has superior properties over standard PVA glues
- No fillers required
- Full BBA approval for 42 days exposure when installed according to manufacturer's instructions
- Conforms to EN 204 / D3

#### Important information about CaberFix D4

All professionals and industrial users of CaberFix D4 must complete training before using products containing more than 0.1% of monomeric diisocyanates - for details and training visit <https://uk.westfraser.com/safe-handling-training-for-pu-adhesives/>

Product application\*

	CaberFloor P5	CaberDek	CaberShieldPlus	CaberAcoustic
<b>CaberFix D4</b>		•	•	
<b>CaberFix D3</b>	•	•		•
<b>CaberFix Joint&amp;Joist</b>	•	•	•	•
<b>CaberFix Tape</b>		•		
<b>CaberFix X-Treme Tape</b>		•		

\*The above table provides general guidance only. For further advice contact technical.

### CaberFix® X-Treme Tape

Highly durable and scuff-resistant flooring joint tape, formulated to withstand severe winter conditions.

- Bonds well in damp conditions and doesn't lift when wet
- Will work in conditions up to, and including, minus 21 degrees C
- High tack strength won't lift in tough working conditions
- Provides BBA approval for 42 days exposure when installed as part of the CaberFix sealing and fixing system\*

\*When installed according to manufacturer's instructions

### CaberFix® Tape

Polyethylene-coated cloth tape for sealing CaberDek flooring during construction.

- 100% waterproof for sealing exposed joints and perimeter edges
- Easy to tear and conform to irregular surfaces
- UV resistant for durability
- Provides BBA approval for 42 days exposure when installed as part of the CaberFix sealing and fixing system\*

Product quantities	Product	Size	Format	Units per box
<b>Adhesives</b>	CaberFix D4	1kg	Bottle	12
	CaberFix D3	1kg	Bottle	12
	CaberFix Joint&Joist	300ml	Cartridge	12
<b>Tapes</b>	CaberFix X-Treme Tape	48mm x 50m	Roll	12
	CaberFix Tape	48mm x 50m	Roll	24

CaberFloor conforms with



The mark of responsible forestry



\*\* Dependent on type



NEXT PAGE >>

# CaberMDF®

## The professional's range

The versatile MDF range for quality finishing.  
Designed as an economical alternative to hardwood without the inherent defects of knots or grains.

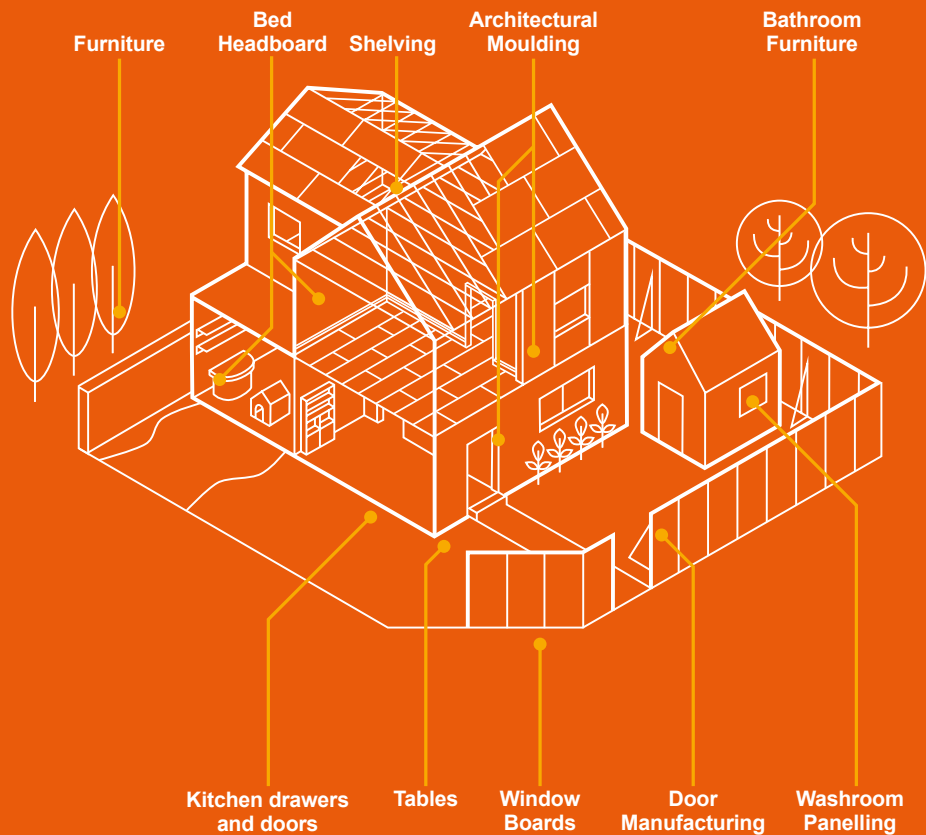

### CaberMDF® Trade

A versatile lightweight board ideal for end uses where weight is a factor

### CaberMDF® Trade MR

All the benefits of CaberMDF Trade with the added advantage of moisture resistance

### CaberMDF® Pro

Consistent density ensures cutting and routing need minimal finishing

### CaberMDF® Pro MR

Premium grade MDF that performs even in occasionally wet / humid environments

### CaberMDF® Industrial

The ultimate MDF, ideal for deeper routing and advanced finishing techniques

# General purpose MDF, renowned for its performance

## CaberMDF<sup>®</sup> Trade

High quality, lightweight MDF with enhanced smooth surface and consistent density.

- Enhanced surface gives a great finish – ideal for painting, paper foils and veneers
- Consistent density ensures it saws, drills, shapes and routs cleanly and easily
- Engineered from UK sourced wood and BS EN 622 parts 1 and 5 accredited

## CaberMDF<sup>®</sup> Trade MR

Lightweight and moisture resistant board for general purpose joinery.

- Performs well in occasionally wet or humid environments
- High quality fibre and internal bond strength gives excellent holding of screws and fastenings
- Saws, drills, shapes and routs cleanly and easily
- No splintering or chipping

### Application\*

Recommended product	Shop fitting	General purpose joinery	Furniture	Wall panelling	Kitchen & bathroom joinery	Exhibition displays	Caravan manufacture	Door manufacture	Fire surrounds	Window boards	Mouldings	Wrap mouldings	Architectural mouldings
<b>CaberMDF Trade</b>	•	•	•			•							
<b>CaberMDF Trade MR</b>	•	•	•		•	•	•						
<b>CaberMDF Pro</b>	•	•	•	•				•	•		•		•
<b>CaberMDF Pro MR</b>	•	•	•	•	•		•	•		•			•
<b>CaberMDF Industrial</b>	•				•			•	•		•	•	•

\*The above table provides general guidance only. It is recommended that you conduct small scale pilot tests to ensure you have the correct grade for your end use.



CaberMDF Trade is perfect for interior joinery where a light panel and fixing strength are essential.

Product details	Thickness mm	Length mm	Width mm	Edge profile	Sheets per pack
<b>CaberMDF Trade</b>	12	2440	1220	SE	75
	12	3050	1220	SE	60
	15	2440	1220	SE	60
	18	2440	1220	SE	50
	18	3050	1220	SE	42
	22	2440	1220	SE	32
	22	3050	1220	SE	32
	25	2440	1220	SE	35
	25	3050	1220	SE	30
<b>CaberMDF Trade MR</b>	12	2440	1220	SE	75
	18	2440	1220	SE	50
	18	3050	1220	SE	40
	25	2440	1220	SE	35

## Premium quality and well suited to detailed working

### CaberMDF<sup>®</sup> Pro

A premium grade MDF with a consistent density for high quality finishing.

- Straight-forward machine and surface finishing
- Consistent density ensures cutting and routing need minimal finishing
- Excellent holding of screws and fastenings
- Saws and drills easily, shapes and routs cleanly

### CaberMDF<sup>®</sup> Pro MR

Premium grade MDF that performs well in occasionally wet or humid environments.

- Consistent high density across the board allowing the most intricate edge profiling and surface routing
- Enhanced, smooth surface is ready for paint, paper foils and veneers
- High quality fibres and internal bond strength for superior holding of screws and fastenings



CaberMDF Pro's consistent density ensures a high quality finish.

### CaberMDF<sup>®</sup> Industrial

Denser design for deep profiles and consistent performance.

- Suitable for use with all woodworking machines and hand tools
- High density design allows advanced finishing and deep, angular profiles
- Gives a superior routed finish
- Enhanced, smooth surface is ready for paint, paper foils and veneers
- Moisture resistant, it performs even in occasionally wet / humid environments  
NB CaberMDF Industrial MR is un-dyed

\*Any modifications to the surface of the board, such as paints, adhesives, laminates etc may affect the fire retardancy performance

#### CaberMDF Pro (SE)

Panel Size (mm)	Sheets per pack per Panel thickness (mm)							
	6	9	12	15	18	22	25	30
2440 × 1220	60	60	60	48	50	32	30	24
2440 × 1830	–	–	–	–	30	–	24	–
3050 × 1220	78	60	48	40	32	32	24	18
3660 × 1220	–	–	–	18	24	–	–	–

#### CaberMDF Pro MR (SE)

Panel Size (mm)	Sheets per pack per Panel thickness (mm)							
	6	9	12	15	18	22	25	30
2440 × 1220	96	76	60	48	40	32	30	24
3050 × 1220	–	60	48	–	32	–	24	18

CaberMDF conforms with



The mark of responsible forestry



## Panel products for every application

### SterlingOSB® Zero

Strength you can build on

Strong, consistent and great value, the SterlingOSB Zero range is ideal for structural applications.

- SterlingOSB Zero OSB3
- SterlingOSB Zero T&G
- SterlingOSB Zero PrimedPlus

### CaberFloor®

Systems you can trust

Versatile flooring system for domestic and commercial floors, CaberFloor is stable, durable and easy to lay.

- CaberFloor P5
- CaberDek
- CaberShieldPlus
- CaberAcoustic
- CaberFix D4 (Adhesive)
- CaberFix D3 (Adhesive)
- CaberFix Joint&Joist (Adhesive)
- CaberFix Tape
- CaberFix X-Treme Tape

### CaberMDF®

The professional's range

Engineered with consistent density for multiple use throughout the shop fitting, construction and furniture industries.

- CaberMDF Trade
- CaberMDF Trade MR
- CaberMDF Pro
- CaberMDF Pro MR
- CaberMDF Industrial

Application	SterlingOSB Zero	CaberFloor	CaberMDF
Roofing	●		
Flooring	●	●	
Walling / Partitioning	●		
Timber frames	●	●	●
Security	●		
Shopfitting	●	●	●
Walkways	●		
Screening	●		
Furniture	●		●
Other	●	●	●

\*The above table provides general guidance only. It is recommended that you conduct small scale pilot tests to ensure you have the correct grade for your end use.

# Roofing

Flat roof decking and pitched roof sarking



For sarking use SterlingOSB Zero OSB3 T&G. No knots or voids means reliable fixings across the board and the T&G profile helps increase the lifespan of the roof.



## Roofing

Recommended product:

### SterlingOSB® Zero® T&G

Specifically designed for flat roofing and pitched roofing, it is quick and easy to install, while ensuring full compliance to BS 6229:2003

#### Roofing guidance

The following roofing specific advice should be noted:

#### Roofing

- Panels must be laid with the long edges at 90° to supports, and short edge joints must be staggered
- All short edges must be supported on joists or noggins
- Panel edges must bear approx. 20mm into joists
- Nailing must be at least 8mm from the panel edges
- The tongue and groove edge does not require to be continuously supported
- SterlingOSB Zero's smooth surface gives improved adhesion qualities for all flat roofing applications
- Fully BBA approved

#### Fixings

SterlingOSB Zero T&G should be fixed using approx. 3mm diameter ring-shank nails or screws, 50mm long at 100mm centres across the supporting joists.

#### Expansion gaps

It is well documented and strongly recommended that additional movement gaps are incorporated in large roof areas or long runs. An expansion provision should be allowed of 2mm per metre plus 1mm for every metre above 12m of the width or breadth of the area. On large roofs, a movement joint should be included every 12m approximately in either direction or at the particular requirement of the advising Structural Design Engineers / Architects. This movement joint should be approx. 25mm.

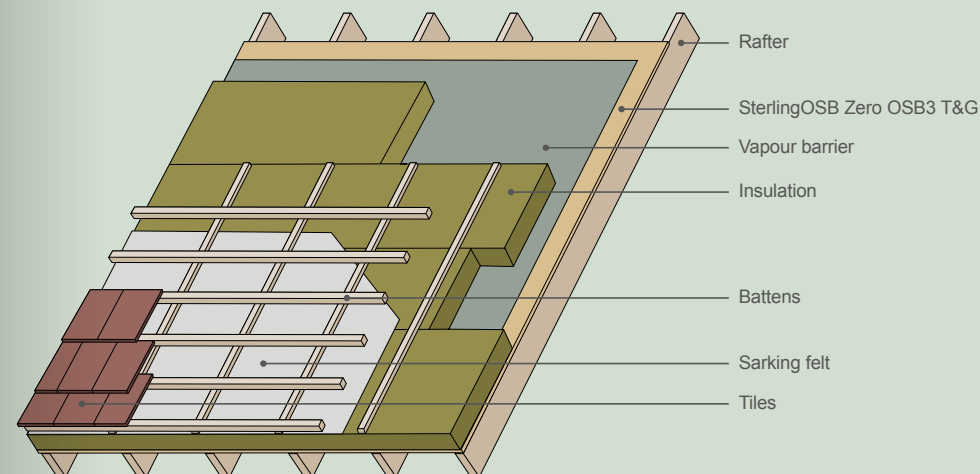

#### Ventilation

Design and applications of panels in flat roof decking is covered in section 2.5 of 'Panel Guide' issued by Wood Panel Industries Federation (WPIF).

#### Safety

As roof decking may be slippery when wet or covered with frost, snow, ice or sawdust, installers should wear rubber soled footwear. The use of a safety harness is recommended.

#### Coverings

A range of proprietary products may be used to cover SterlingOSB Zero T&G - refer to appropriate trade associations for guidance e.g. The National Federation of Roofing Contractors who can be contacted on 02076 387 663.

#### Specification guidance

Further guidance on the selection and use of wood-based panels and other essential design information can be found in: WPIF Panel Guide, BS 6229, BBA Agrément Certificate No 01/3857 and DD ENV 12872:2000.

For further details please contact West Fraser's UK technical support or;

- [www.wpif.org.uk](http://www.wpif.org.uk)
- [www.bbacerts.co.uk](http://www.bbacerts.co.uk)

#### SterlingOSB Zero

For further product information, see page 10  
For technical product information, see page 69



## Flooring

New-build, replacement, domestic and commercial

Homes, schools, hospitals and offices. No matter what size or shape of floor you are laying, CaberFloor is an advanced product range designed to fit all applications.





## Flooring

Recommended products:

 **CaberFloor P5**

 **CaberDek**

 **CaberShield+**

 **CaberAcoustic**

 **CaberFix**

High-strength flooring systems for domestic and commercial flooring, they are stable, durable and easy to lay while complying to BS EN 312.

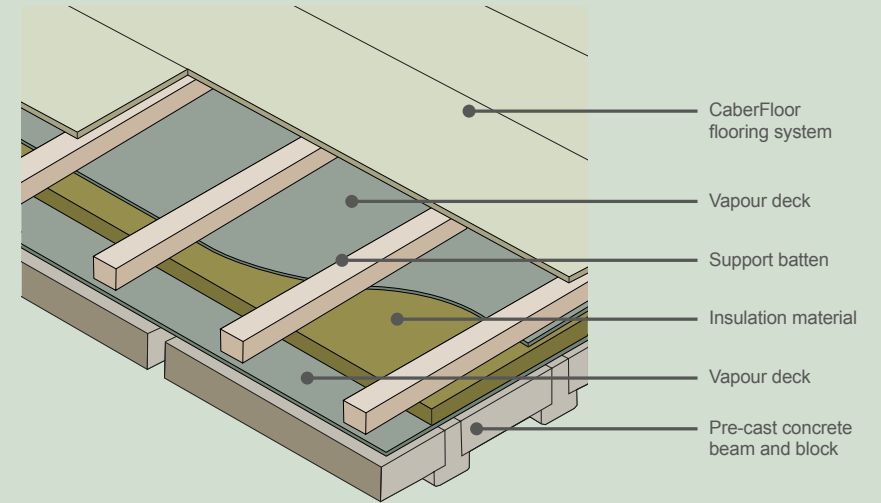

Best product for application

	CaberFloor P5	CaberFloor P5	CaberDek	CaberDek	CaberShieldPlus	CaberAcoustic	CaberAcoustic
<b>Thickness (mm)</b>	18	22	18	22	22	28	32
<b>Dry Domestic</b>	•	•	•	•	•	•	•
<b>Domestic new build</b>	•	•	•	•	•	•	•
<b>Refurbishment</b>	•	•	•	•	•	•	•
<b>Commercial</b>		•		•	•		•

**CaberFloor**  
For further product information, see page 14  
For technical product information, see page 78

\*The above table provides general guidance only. For further advice contact technical.

## Choose the most suitable flooring system

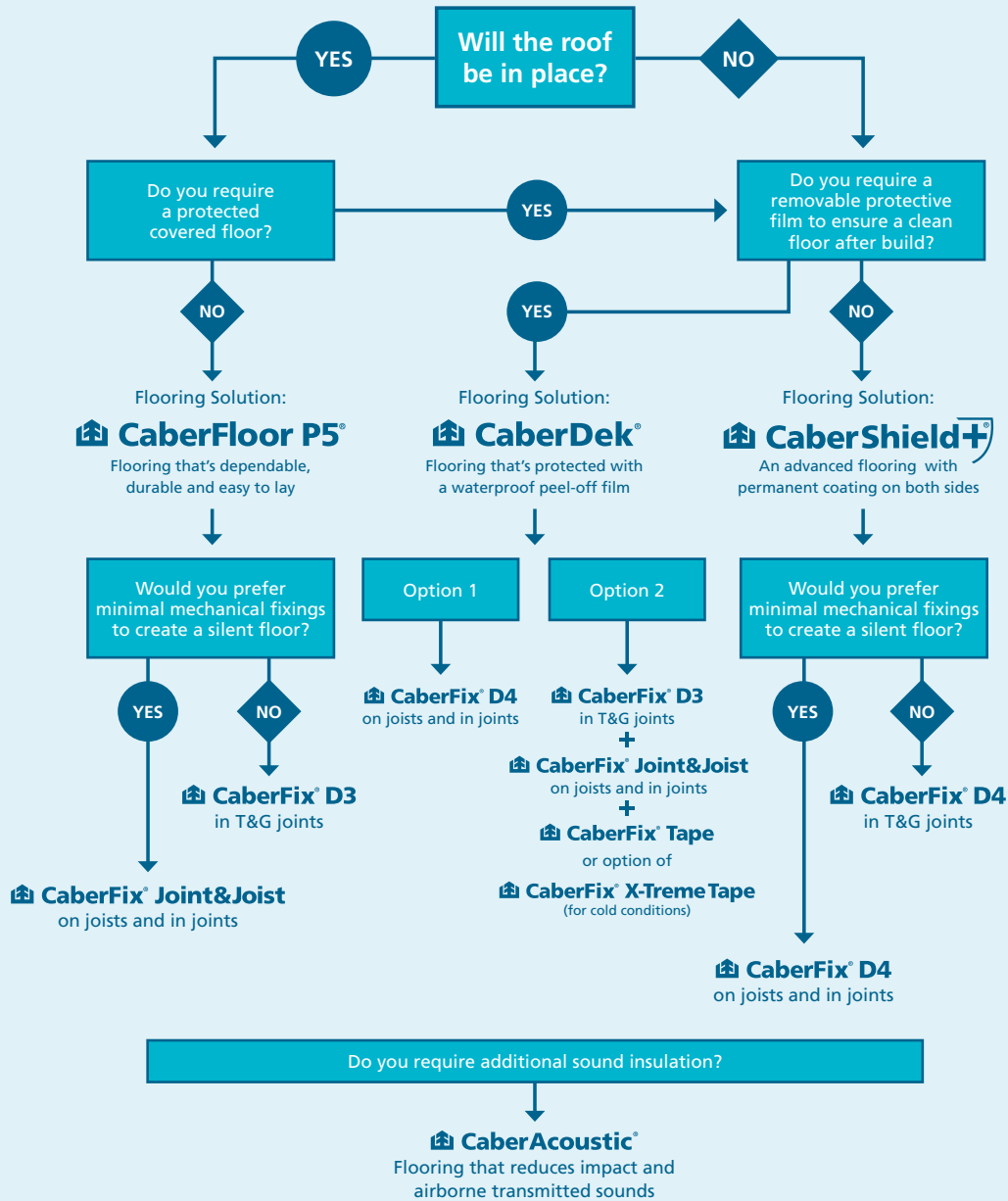

## CaberFloor P5 installation quick guide

### Step 1. Adhesive I-joint application

- Apply one continuous bead of CaberFix Joint&Joist to the top of the joist or I-joist
- Use CaberFix Joint&Joist on joists and noggins in the area that is about to be directly laid
- Use a 6mm bead

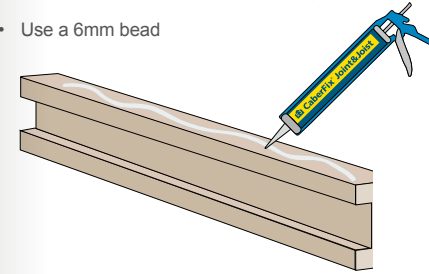

### Step 2. Secret fixing & adhesive application

- Continue laying boards in a staggered format. Panels should be secretly screwed through the tongue at T&G joints at every joist
- Apply a 6mm bead of CaberFix Joint&Joist to T&G joints as shown

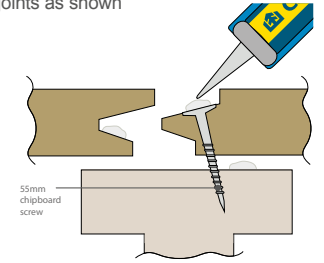

### Step 3. Fixings per board / perimeter & sealing

- Fix perimeter as per diagram
- Leave minimum 10mm expansion gap at perimeter

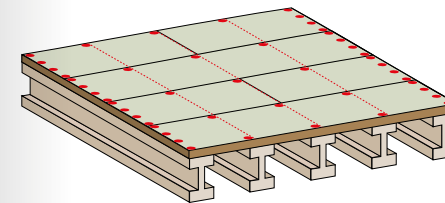

Floor fixing diagram (• Mechanical fixing positions)

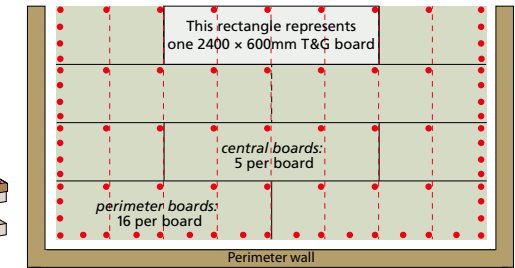

## CaberFix® Joint&Joist

CaberFloor P5 is best used with CaberFix Joint&Joist, an adhesive that will adhere to a wide variety of materials, creating a strong, silent, and flexible waterproof bond.



- Provides strength, stability and flexibility when joining CaberFloor floors and joists
- Excellent resistance to temperature extremes
- Silent bonding layer between floors and joists
- Bonds in damp conditions to a variety of materials; 100% waterproof bond

# Installation quick guide

## CaberDek with D4 installation instructions

### Step 1. Adhesive I-joint application

Apply one continuous ~6mm bead of CaberFix D4 adhesive to the top of the joist or I-joint. Use CaberFix D4 adhesive on joists and noggins in the area that is about to be directly laid.

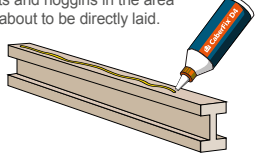

### Step 2. Perimeter panel fixing

Panels should be fixed at the perimeter, using annular ringshank nails or screws at 200–300mm centres. Fix flush or just below panel surface.

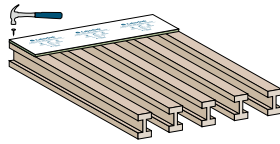

### Step 3. Adhesive T&G application

A liberal application of CaberFix D4 adhesive should be made to both the tongue and groove of the profile joint of each panel to ensure that the entire joint is bonded. When the boards are pushed together a small amount of adhesive should squeeze out of the T&G, sufficient to cover any exposed chipboard on the joint.

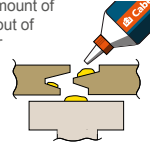

### Step 4. Panel fixings

Continue laying boards in a staggered format. Panels may be secretly nailed through the tongue at T&G joints. For optimum performance we recommend a minimum of 5 mechanical fixings per 22 x 2400 x 600mm board when fitted at 600mm centres, i.e. 1 fixing per joist.

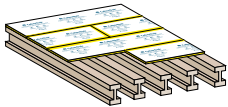

### Step 5. Complete sealing

When installing CaberDek, any film that has peeled back from edges or T&G should be stuck back down using CaberFix D4 adhesive. For complete weather-tightness apply CaberFix D4 to exposed nail heads, cut edges and any exposed perimeter edges.

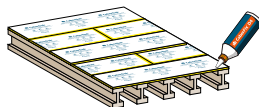

### Step 6. Clean down

When all construction and decoration work is complete and the building is weather tight, the deck should be cleaned down: Remove the peel-off film by pulling slowly but firmly from the short end.

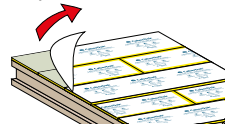

## CaberDek with CaberFix D3 + Joint&Joist + Tape installation instructions

### Step 1. Adhesive I-joint application

Apply one continuous ~6mm bead of CaberFix Joint&Joist adhesive to the top of the joist or I-joint, using a skeleton gun. Use CaberFix Joint&Joist adhesive on joists and noggins in the area that is about to be directly laid.

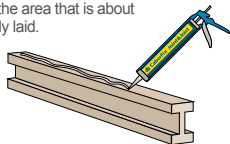

### Step 2. Perimeter panel fixing

Panels should be fixed at perimeter using annular ringshank nails or screws at 200-300mm centres. Fix flush or just below panel surface 25mm from edge of board.

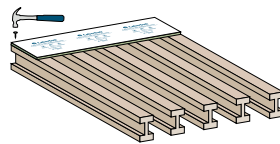

### Step 3. Adhesive T&G application

A liberal application of CaberFix D3 PVA adhesive should be made to both the tongue and groove of the profile joint of each panel to ensure that the entire joint is bonded.

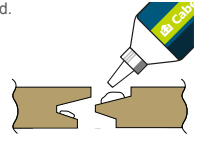

### Step 4. Panel fixings

Continue laying boards in a staggered format. Panels may be secretly nailed through the tongue at T&G joints. For optimum performance we recommend a minimum of 5 mechanical fixings per 22 x 2400 x 600mm board when fitted at 600mm centres, i.e. 1 fixing per joist.

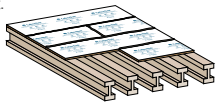

### Step 5. Taping

Immediately after a run of panels have been fixed, all board joints, nail runs and exposed edges around the perimeter should be sealed using CaberFix Tape or in harsh conditions with CaberFix X-Treme tape.

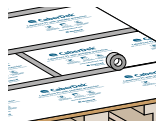

### Step 6. Clean down

When all construction and decoration work is complete and the building is weather tight, the deck should be cleaned down: Remove the peel-off film by pulling slowly but firmly from the short end.

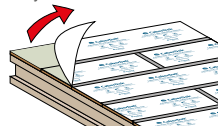

For detailed CaberFloor flooring installation advice, see website

### Important information about CaberFix D4

All professionals and industrial users of CaberFix D4 must complete training before using products containing more than 0.1% of monomeric diisocyanates - for details and training visit <https://uk.westfraser.com/safe-handling-training-for-pu-adhesives/>

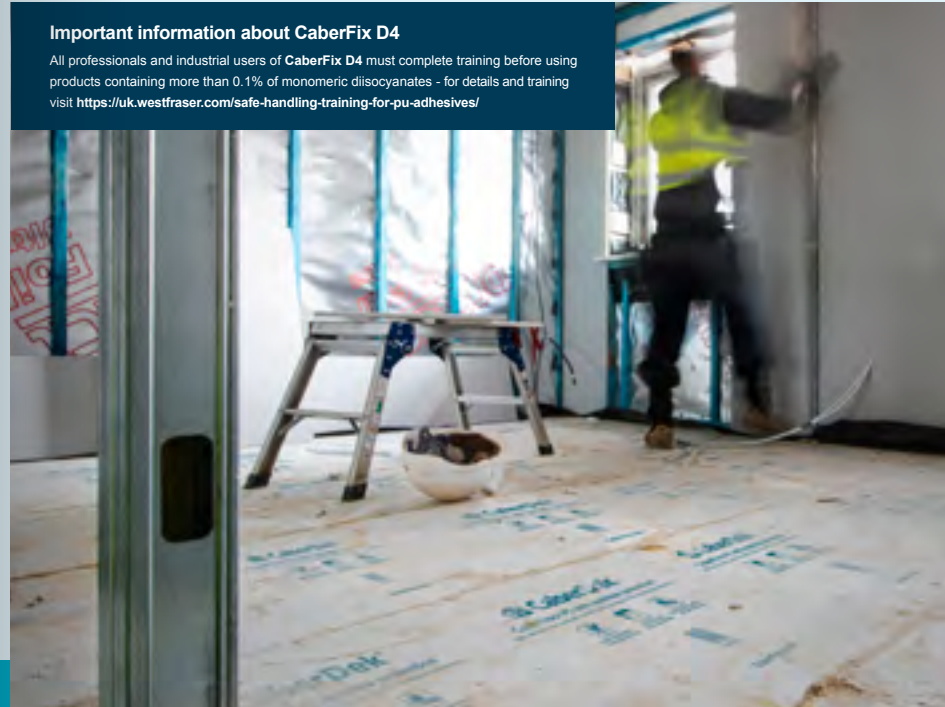

CaberDek is perfect for situations where flooring is laid before the building is weather tight and whilst there is still likelihood of construction mess.



## CaberFix® D4

CaberDek and CaberShieldPlus are best used with CaberFix D4, an adhesive that bonds flooring to joists, T&G joints and seals exposed perimeter and edges to provide full BBA approval for up to 60 days exposure.

- Foaming adhesive – easy to see T&G joints are sealed
- BBA approved for up to 60 days exposure\*
- One adhesive – making the job more efficient and cost-effective

\*When installed according to manufacturer's instructions. 60 days weather exposure applies to use with CaberShieldPlus only

## Installation quick guide

### CaberShieldPlus with D4

#### Step 1. Adhesive I-joist application

Apply one continuous ~6mm bead of CaberFix D4 adhesive to the top of the joist or I-joist. Use CaberFix D4 adhesive on joists and noggins in the area that is about to be directly laid.

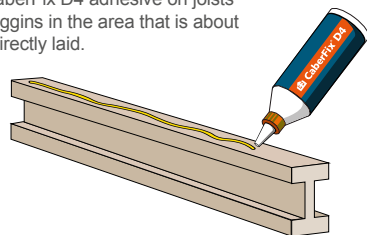

#### Step 2. Perimeter panel fixing

Panels should be fixed at perimeter, using annular ringshank nails or screws at 200–300mm centres. Fix flush or just below panel surface.

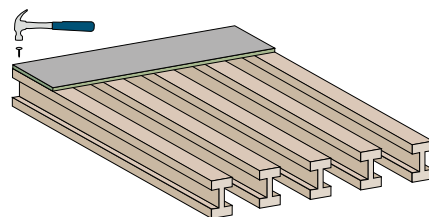

#### Step 3. Adhesive T&G application

A liberal application of CaberFix D4 adhesive should be made to both the tongue and groove of the profile joint of each panel to ensure that the entire joint is bonded. When boards are pushed together a small amount of adhesive should be squeezed out of the T&G. This seals the joint at the T&G.

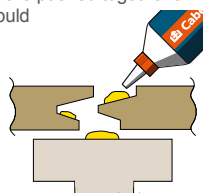

#### Step 4. Panel fixings

Continue laying boards in a staggered format. Panels may be secretly nailed through the tongue at T&G joints. For optimum performance we recommend a minimum of 5 mechanical fixings per 22 × 2400 × 600mm board when fitted at 600mm centres, i.e. 1 fixing per joist.

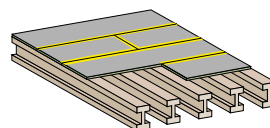

#### Step 5. Complete sealing

For complete weather-tightness apply CaberFix D4 to exposed nail heads, cut edges and any exposed perimeter edges.

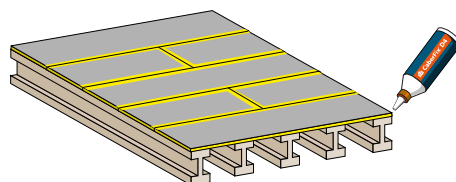

#### Step 6. Clean down

When all construction and decoration work is complete and the building is weather tight, the deck should be cleaned down. Once dry, any excess adhesive should be removed with a scraper.

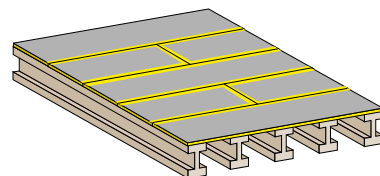

### CaberAcoustic with D3

#### Step 1. Deck preparation

Before laying CaberAcoustic on top of a timber floor, ensure all previous adhesives are set and the floor is cleaned down, level and dry. If laying on a concrete base, ensure a damp-proof membrane is used first.

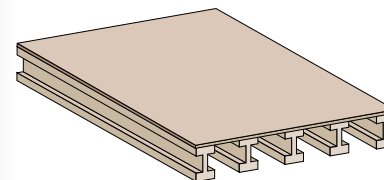

#### Step 2. Perimeter flanking

Place the flanking strip against the wall /perimeter of the floor – no fixings are required.

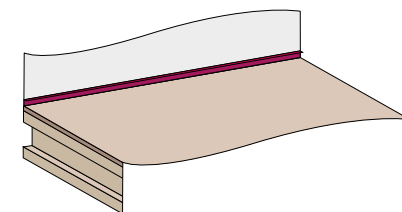

#### Step 3. Perimeter panel positioning

Lay the first CaberAcoustic panel (felt side down) and ensure the panel is pressed firmly against the flanking strip to create an airtight seal.

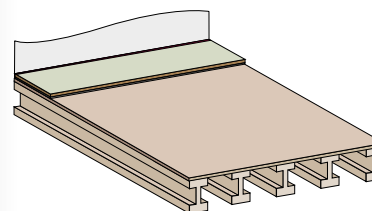

#### Step 4. T&G adhesive application

Continue to lay CaberAcoustic boards in a staggered format and apply a 6mm bead of CaberFix D3 to the T&G joints.

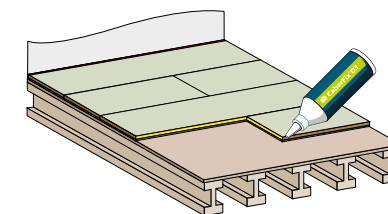

#### Step 5. Complete sealing

Ensure the floor is well sealed against air gaps. There must be no fastenings through the floating floor, with the only exception being where two panels join which have only cut edges, for example across a door opening.

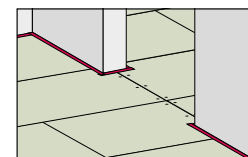

For detailed CaberFloor flooring technical advice, see page 78



## Walling / Partitioning

Wall sheathing, partitioning and Structural Insulated Panels (SIPs)

Forget about knots or voids spoiling your plans, SterlingOSB Zero lets you just get on with the job.

# Walling / Partitioning

Recommended products:

## SterlingOSB® Zero® OSB3

Easy to saw, drill, nail, plane or file, SterlingOSB Zero is perfect for structural use in dry and humid conditions.

## SterlingOSB® Zero® PrimedPlus

Our coated board is ideal for walkways, exhibitions, barriers and screening. It's ready for immediate use or graphics and is a blank canvas for your messages.

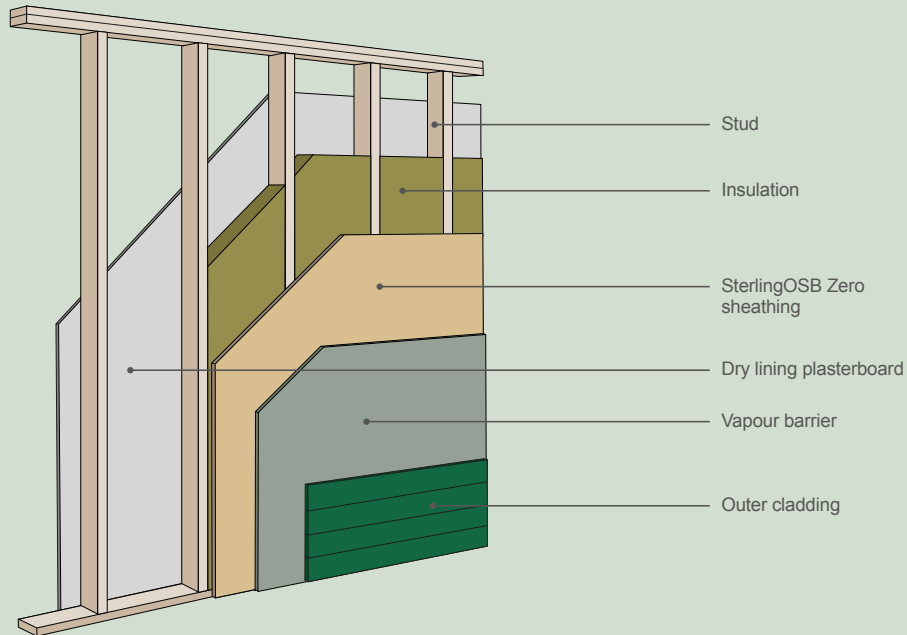

Application\*

		SterlingOSB Zero OSB3	SterlingOSB PrimedPlus
Dry conditions	Exhibition displays	•	•
	Interior decorative	•	•
	Internal hoarding	•	•
	Dry lining	•	•
Humid conditions	Wall sheathing	•	•
	Partitioning	•	•
	Agricultural buildings	•	•
	Portable buildings / Caravans	•	•

**SterlingOSB Zero**  
For further product information, see page 10  
For technical product and installation guidance, see page 69

### Walling guidance

The following walling specific advice should be noted:

#### Fixings

- Panels must be laid with the long edges at 90° to supports and short edge joints must be staggered
- All short edges must be supported on studs or noggins
- Panel edges must bear approx. 18mm onto joists
- Nailing must be at least 8mm from the panel edges
- Panels should be fixed using approx. 3mm ring-shank nails or screws whose length is 2.5 times the thickness of the panel

#### Expansion gaps

With all square edged panels a 3mm expansion gap should be allowed between boards and edges.

Spans & nailing centres	Sheathing
Thickness (mm)	9 mm
Max. span* (domestic)	610 mm
Nail centres (edges)	150 mm
Nail centres (intermediate)	300 mm
Weight (approx.)	3.5 kg/m <sup>2</sup>
Face smooth nail retention**	158 N
Edge screw retention	—
Face screw retention	625 N

\*The above table provides general guidance only. It is recommended that you conduct small scale pilot tests to ensure you have the correct grade for your end use.



## Timber Frames

All aspects of a house build; structural, flooring, interiors

High grade boards speed up construction because minimal finishing is required.



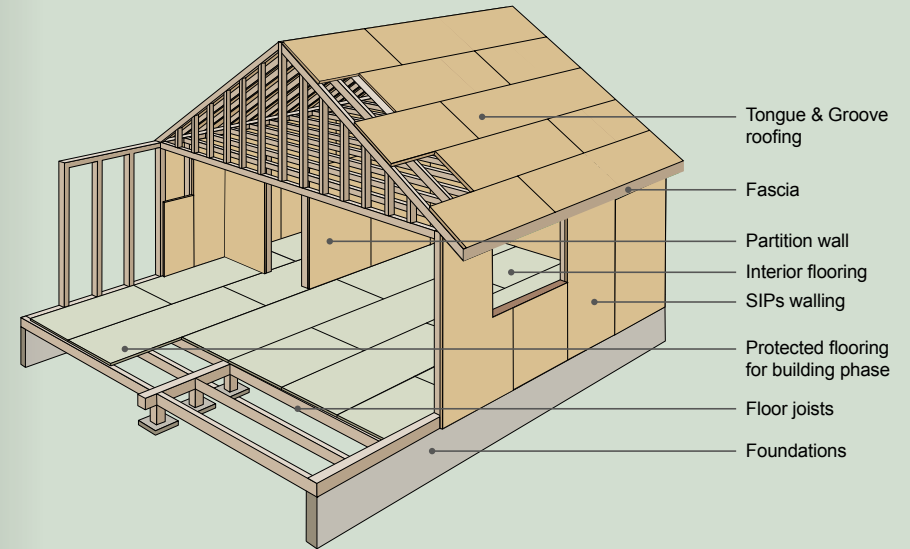

## Timber Frames

Recommended products:

SterlingOSB® Zero® OSB3

SterlingOSB® Zero® T&G

CaberFloor P5®

CaberDek®

CaberShield+®

CaberAcoustic®

CaberFix®

SterlingOSB Zero and CaberFloor include a wide range of grades specifically designed for structural use and with unique properties to speed up the construction phase.

Application\*

	SterlingOSB Zero OSB3	SterlingOSB Zero T&G	CaberFloor P5	CaberDek	CaberShieldPlus	CaberAcoustic
Wall sheathing (humid conditions)	•	•				
Internal hoarding / decorative (dry conditions)	•	•				
Dry lining	•	•				
Roofing (pitched and flat)		•				
Domestic flooring (dry conditions)		•	•	•	•	•
Domestic flooring (clean finish in exposed conditions)				•		
Domestic flooring (exposed construction phase)				•	•	

\*The above table provides general guidance only. It is recommended that you conduct small scale pilot tests to ensure you have the correct grade for your end use. CaberAcoustic is an overlay board.

### SterlingOSB Zero

For further product information, see page 10  
For technical product information, see page 69

### CaberFloor

For further product information, see page 14  
For technical product information, see page 78

# Security

Shuttering, site hoarding and boarding-up



The inherent strength of SterlingOSB Zero makes it the natural choice for securing a site or property.

# Security

Recommended products:

## SterlingOSB® Zero OSB3

Naturally strong and hard-wearing, SterlingOSB Zero OSB3 is tougher than most softwood plywood and is easy to use with no knots, voids or delaminating problems.

## SterlingOSB® Zero PrimedPlus

Our coated board is ideal for walkways, exhibitions, barriers and screening. It's ready for immediate use or graphics and is a blank canvas for your messages.



### Features and benefits

- Highly versatile structural board that can be used in load bearing situations
- Stronger and tougher than most softwood plywood
- Quick and easy to work with giving added site security
- SterlingOSB Zero PrimedPlus is coated, and ready for immediate use or graphics
- The first and only UK-made OSB with zero-added formaldehyde
- Made from responsibly sourced timber with a low carbon footprint

#### Application\*

	SterlingOSB Zero OSB3	SterlingOSB Zero PrimedPlus
Site hoarding	•	•
Fencing	•	
Screening		•
Walkway		•
Security		•

\*The above table provides general guidance only. It is recommended that you conduct small scale pilot tests to ensure you have the correct grade for your end use.

### SterlingOSB Zero

For further product information, see page 10  
For technical product information, see page 69

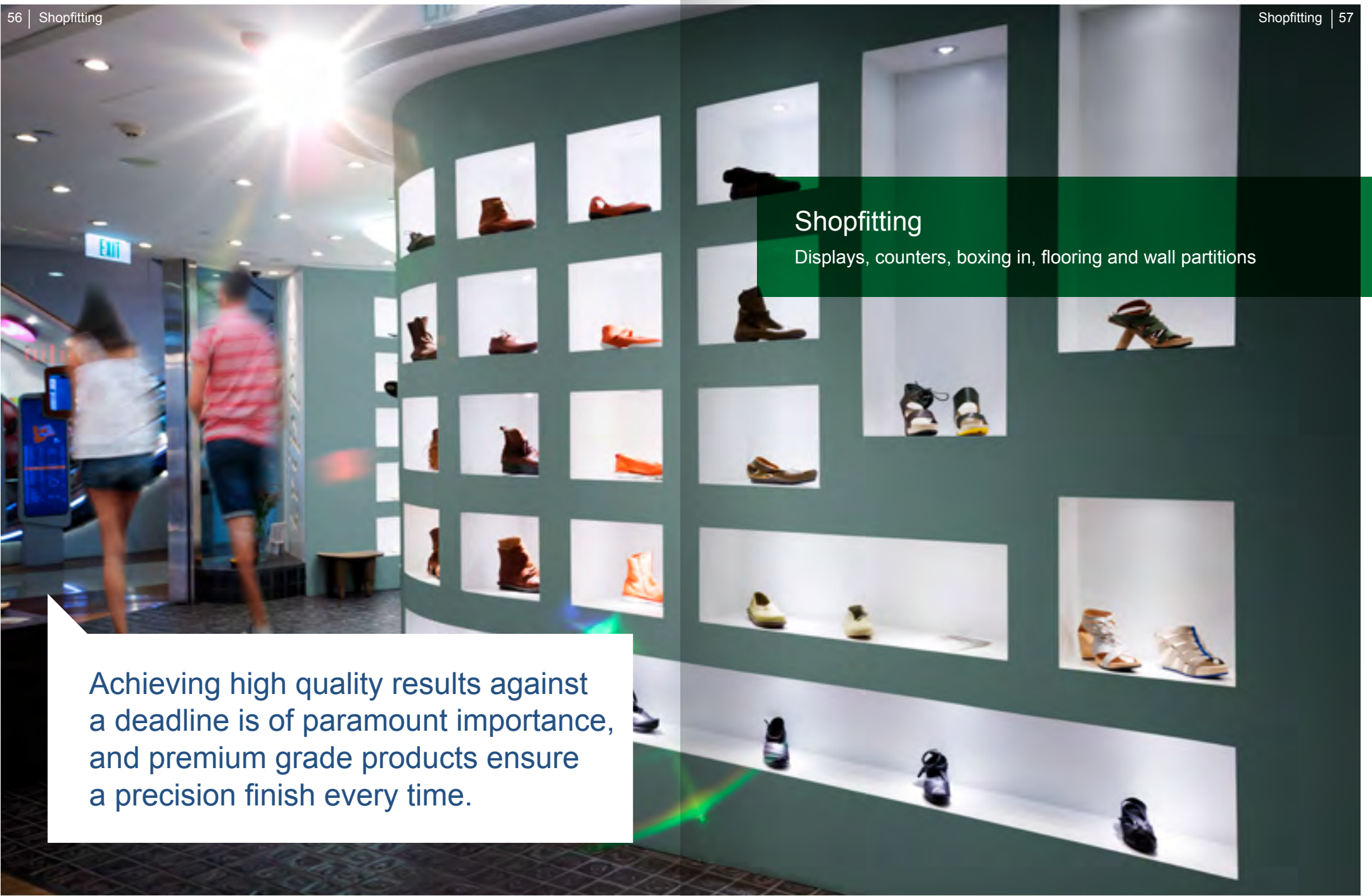

## Shopfitting

Displays, counters, boxing in, flooring and wall partitions

Achieving high quality results against a deadline is of paramount importance, and premium grade products ensure a precision finish every time.

## Shopfitting

Recommended products:

 **CaberMDF®  
Trade**

 **CaberMDF®  
Trade MR**

 **CaberMDF®  
Pro**

 **CaberMDF®  
Pro MR**

 **CaberMDF®  
Industrial**

 **CaberFloor P5®**

 **CaberDek®**

 **CaberShield+®**

 **CaberAcoustic®**

 **CaberFix®**

 **SterlingOSB® Zero®  
OSB3**

 **SterlingOSB® Zero®  
T&G**

 **SterlingOSB® Zero®  
PrimedPlus**

CaberMDF, CaberFloor and SterlingOSB Zero include a wide range of grades to suit commercial applications where timing and quality are primary factors.

Best product for application

Application*	CaberMDF Trade	CaberMDF Trade MR	CaberMDF Pro	CaberMDF Pro MR	CaberMDF Industrial	CaberFloor P5	CaberDek	CaberShieldPlus	CaberAcoustic	SterlingOSB Zero OSB3	SterlingOSB Zero T&G	SterlingOSB PrimedPlus
Thickness range (mm)**	12-25	12-25	6-30	6-30	15-25	22	22	22	32	9-18	18-22	18
General purpose joinery	●	●	●	●								
Simple designs with minimal profiles			●	●	●					●	●	
Humid conditions		●		●	●					●	●	●
Deep routed profiles					●							
Advanced, deep routed profiles and painted finishes					●							
Architectural mouldings; skirting and architraves			●	●	●							
Commercial flooring						●	●	●	●			
Graphics and marketing messages												●

\* The above table provides general guidance only. It is recommended that you conduct small scale pilot tests to ensure you have the correct grade for your end use.

\*\* Other thicknesses are available on request.

### CaberMDF

For further product information, see page 22  
For technical product information, see page 90

### CaberFloor

For further product information, see page 14  
For technical product information, see page 78

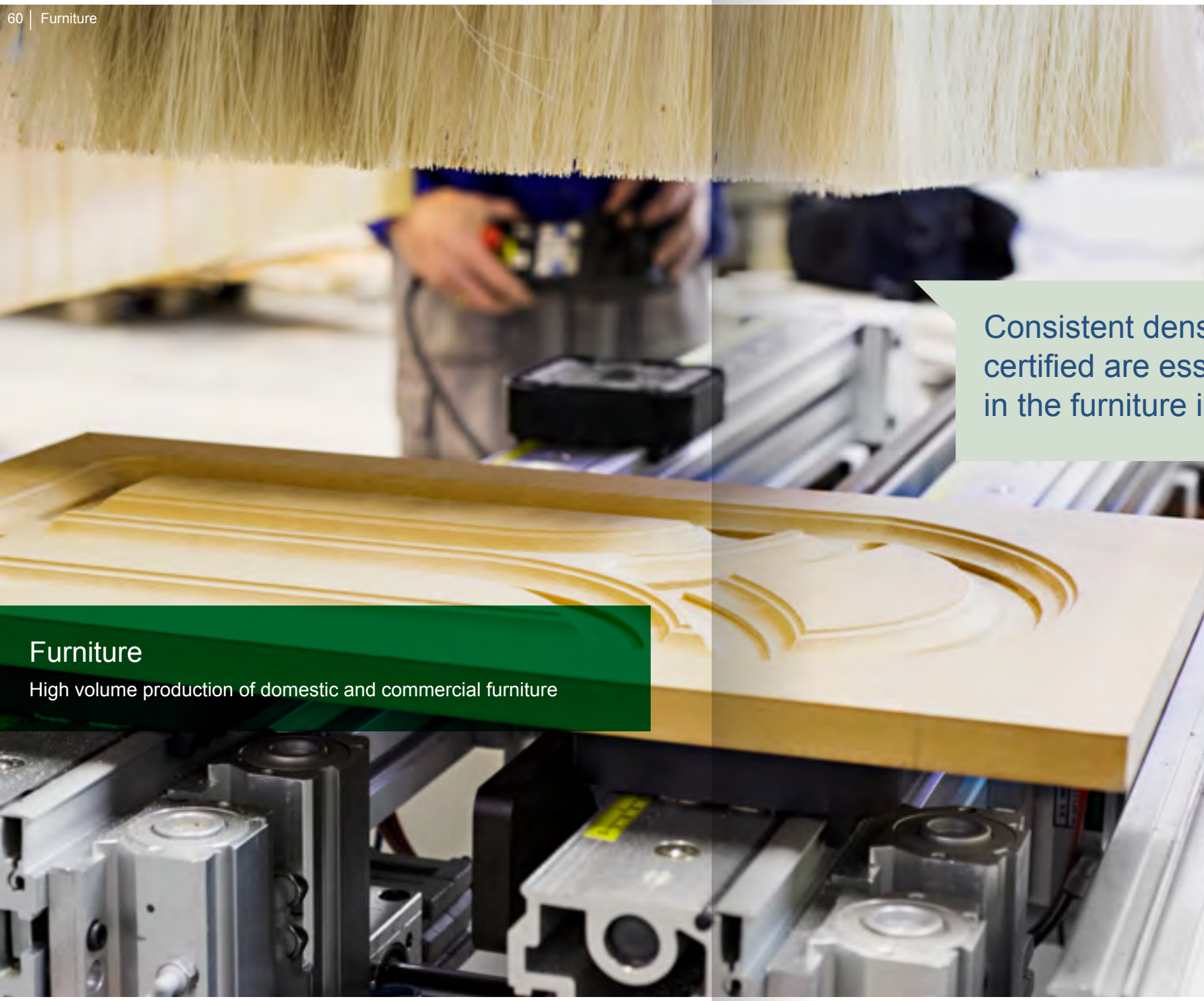

Consistent density and FSC® certified are essential qualities in the furniture industry.

## Furniture

High volume production of domestic and commercial furniture



CaberMDF and SterlingOSB Zero are some of the most popular materials in the furniture industry. With their consistent density providing an ease and speed of workability, they form the backbone and fascias of a huge variety of items.

## Furniture

Recommended products:

 **CaberMDF®  
Trade**

 **CaberMDF®  
Pro**

 **CaberMDF®  
Industrial**

 **CaberMDF®  
Trade MR**

 **CaberMDF®  
Pro MR**

 **SterlingOSB® Zero  
OSB3**

Best product for application

Application*	CaberMDF Trade	CaberMDF Trade MR	CaberMDF Pro	CaberMDF Pro MR	CaberMDF Industrial	SterlingOSB Zero OSB3
Chairs, tables, cabinets	•	•	•	•	•	
Bed frames	•		•		•	
Kitchen and bathroom furniture		•		•	•	
Wardrobes	•		•		•	
Shelving			•	•	•	•
Couch frames						•

### CaberMDF

For further product information, see page 22  
For technical product information, see page 90

### SterlingOSB Zero

For further product information, see page 10  
For technical product information, see page 69

\* The above table provides general guidance only. It is recommended that you conduct small scale pilot tests to ensure you have the correct grade for your end use.





## Other

Moulding and packaging



Highly durable and exempt from phytosanitary regulation, SterlingOSB Zero is perfect for international shipping crates.

With such a consistent density, machines can be easily set-up for complex routs and profiling.

Though individually unique, CaberMDF and SterlingOSB Zero both share the common benefit of consistent density, making tool set-up simple and finishing time minimal.

## Moulding and packaging

Recommended products:

 CaberMDF®  
Trade

 CaberMDF®  
Trade MR

 CaberMDF®  
Pro

 CaberMDF®  
Pro MR

 CaberMDF®  
Industrial

 SterlingOSB® Zero  
OSB3

Best product for application

Application*	CaberMDF Trade	CaberMDF Trade MR	CaberMDF Pro	CaberMDF Pro MR	CaberMDF Industrial	SterlingOSB Zero OSB3
Fire surrounds			•		•	
Staircases			•		•	
Wall panelling		•		•	•	
Doors			•	•	•	
Architectural moulding			•	•	•	
Packaging						•
Pallets / crates						•

### CaberMDF

For further product information, see page 22  
For technical product information, see page 90

### SterlingOSB Zero

For further product information, see page 10  
For technical product information, see page 69



\* The above table provides general guidance only. It is recommended that you conduct small scale pilot tests to ensure you have the correct grade for your end use.

# TECHNICAL INFORMATION

At West Fraser, our experienced technical team is on hand to deal with enquiries from architects, builders, contractors – in fact anyone involved in the specification or use of West Fraser's engineered wood-based panels.

## MSDS

Material Safety Data-Sheets are available for all West Fraser products. Please contact West Fraser Technical Support or visit:

[uk.westfraser.com](http://uk.westfraser.com)

## Technical Support

For specialist product advice:

### SterlingOSB Zero

Steve McTaggart  
T: 01463 791 764

### CaberFloor CaberMDF

Alan Kirkpatrick  
T: 01786 819 205

## General Enquiries

For general West Fraser information:

T: 01786 819 225

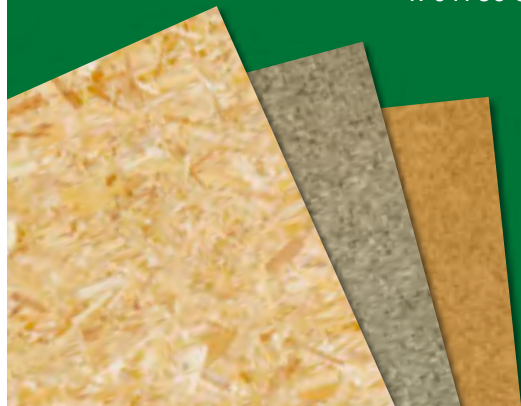

## SterlingOSB Zero technical data

### Product specification

Property	EN Standard	Unit	Specification
Tolerance on the mean density within a board	323	mm	±15%
Length / Width Deviation	324-1	mm	±3
Thickness Deviation – unsanded	324-1	mm	±0.8
Thickness Deviation – sanded	324-1	mm	±0.3
Squareness – tolerance	324-2	mm/m	2
Straightness	324-2	mm/m	1.5
Linear Expansion (65%- 85% relative humidity)		%	0.15
Thermal Conductivity 'K' Value	13986	w/(m.k)	0.13
Reaction to Fire (BS EN 135 01-1)	13986		D
Formaldehyde	120	mg/100g	<8

### Load bearing for use in humid conditions:

Requirements for specified mechanical & swelling properties

Property	EN Standard	Unit	OSB3 Requirement		
			6–10 mm	>10 to <18	18–25 mm
Moisture Content	322	%	2-12	2-12	2-12
Bending Strength – major axis	310	N/mm <sup>2</sup>	22	20	18
Bending Strength – minor axis	310	N/mm <sup>2</sup>	11	10	9
Modulus of Elasticity in bending – major axis	310	N/mm <sup>2</sup>	3500	3500	3500
Modulus of Elasticity in bending – minor axis	310	N/mm <sup>2</sup>	1400	1400	1400
Internal Bond (IB)	319	N/mm <sup>2</sup>	0.34	0.32	0.30
Thickness Swelling (24hr immersion)	317	%	15	15	15
Bending Strength after cyclic test – major axis	321+ 310	N/mm <sup>2</sup>	9	8	7

### Product sizes available

Product	Size (mm)	Thickness (mm)
SterlingOSB Zero OSB3 – Square Edged	2400 × 1200	9, 11, 15, 18
	2440 × 1220	9, 11, 15, 18
	2700 × 1200	9
SterlingOSB Zero OSB3 T&G – 2 edges	2400 × 1200	18, 22
	2440 × 1200	18, 22
SterlingOSB Zero OSB3 T&G – 4 edges	2400 × 590	18

Other sizes are available on request.

### Boards per pack

Thickness (mm)	9	11	15	18	22
Number of boards	100	84	60	50	41

## SterlingOSB Zero technical data *continued*

### Characteristic values of boards complying with BS EN 300:

#### OSB3: Load bearing boards for use in humid conditions

This gives information on the characteristic values of both mechanical properties and density for those wood based panels the values of which, unless specified to the contrary, have been determined using the sampling techniques set out in BS EN 1058 and the testing procedures given in BS EN 789. The minimum characteristic values for OSB complying with BS EN 300.

When OSB3 is used structurally under service class 1 conditions, the characteristic values of the mechanical properties and density given in the tables below will apply. These require to be modified according to EC5 for duration of load ( $k_{mod}$ ,  $k_{def}$ ).

When OSB3 is used structurally under service class 2 conditions, the characteristic values of the mechanical properties and density given in Table 1 shall be modified according to EC5 for both service class and duration of load ( $k_{mod}$ ,  $k_{def}$ ).

#### Characteristic density (kg/m<sup>3</sup>) and strength (N/mm<sup>2</sup>) values

Thickness (mm)	Density	Bending		Tension		Compression		Panel Shear	Planar Shear
		$f_m$		$f_t$		$f_c$			
$t_{nom}$	$\rho$	0	90	0	90	0	90	$f_v$	$f_r$
> 6 to 10	550	18.0	9.0	9.9	7.2	15.9	12.9	6.8	1.0
> 10 to 18	550	16.4	8.2	9.4	7.0	15.4	12.7	6.8	1.0
> 18 to 25	550	14.8	7.4	9.0	6.8	14.8	12.4	6.8	1.0

#### Mean stiffness values (N/mm<sup>2</sup>)

Thickness (mm)	Bending		Tension		Compression		Panel Shear	Planar Shear
	$E_m$		$E_t$		$E_c$			
$t_{nom}$	0	90	0	90	0	90	$G_v$	$G_r$
> 6 to 10	4930	1980	3800	3000	3800	3000	1080	50
> 10 to 18	4930	1980	3800	3000	3800	3000	1080	50
> 18 to 25	4930	1980	3800	3000	3800	3000	1080	50

The 5% characteristic values for stiffness should be taken as 0.85 times the mean values given in the tables above. Other properties not given in the tables shall comply with the requirements given in BS EN 300 for the grades OSB/2 or OSB/3.

### Permissible Vertical Loads

Design vertical point (line) and uniformly distributed loads (UDL), per board thickness, per given span – spanning longitudinally, based on:

1. Material properties to BS EN 12369-1:2001 and BS EN 300:2006.
2. Structural design to Eurocode 5 (BS EN 1995-1-1:2004+A2:2014).
3. Performance characteristics as floors and roofs to BS EN 12871:2013.

### Service Classes

Three service classes are defined in Eurocode 5.

#### Service Class 1

Characterised by a moisture content in the materials corresponding to a temperature of 20°C and the relative humidity of the surrounding air only exceeding 65% for a few weeks per year.

#### Service Class 2

Characterised by a moisture content in the materials corresponding to a temperature of 20°C and the relative humidity of the surrounding air only exceeding 85% for a few weeks per year.

#### Service Class 3

Climatic conditions leading to higher moisture contents than in Service Class 2.

### Load Duration Class

Load Duration Class	Order of accumulated duration of characteristic load	Examples of loading
Permanent	More than 10 years	Self weight
Long-term	6 months to 10 years	Storage
Medium-term	1 week to 6 months	Imposed load
Short-term	Less than on week	Snow* and wind
Instantaneous		Accidental load

\*In areas which have a heavy snow load for a prolonged period of time, part of the load should be regarded as medium-term

#### Notes:

1. The design (permissible) loads per span values given in the tables overleaf (1 and 2) are based on the modification factors detailed in Eurocode 5, BS EN 1995-1-1:2004+A2:2014 as well as the requirements of BS EN 12871:2013 and the load factor for variable actions  $\gamma_Q = 1.35$ , under Service Classes 1 and 2 conditions for long-term and medium-term loadings.
2. Point (line) loads are in kN.
3. Uniformly distributed loads are in kN/m<sup>2</sup>.
4. Design load values are given for multi-span (i.e. boards continuous over 3 or more supports) cases.
5. Permissible deflection is considered as: 1/150th of span.
6. The design load, for a particular board / span / service condition / load duration, may be considered as the smaller value of its 'strength limit' and the 'deflection limit'.

**Note:** In accordance with the National Forward to BS EN 12871:2013, no codified deflection limit for panels spanning between joists is specified in the UK. Therefore, if deflection is not a design criterion, then the structural engineer may consider the strength values given in the tables overleaf as the limiting design (permissible) loads.

7. The information and design load values are for guidance only and the liability is excluded.



## SterlingOSB Zero

### Storage

Panels should be banded and stored under cover, on a level base with sufficient bearers to prevent sagging or other distortion. Care should be taken to protect edges. Where the panel is to be stored for a prolonged period, additional bearers should be installed.

An HSE information sheet on the 'safe stacking of sawn material and board materials' is available in our document library at [uk.westfraser.com](http://uk.westfraser.com)

### Conditioning

In common with other wood and wood-based products, OSB may expand or contract slightly when exposed to changes of moisture in the atmosphere. Boards should be allowed to reach equilibrium by storing them under the atmospheric conditions in which they are to be used for a minimum of 48 hours prior to installation.

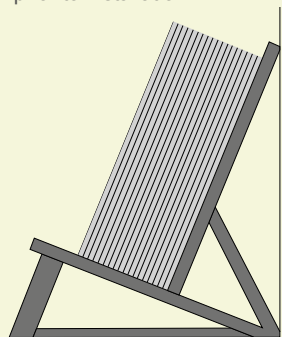

Correct method of edge stacking

### Coating

When choosing a coating system, the desired longevity, decorative effect and level of maintenance should be considered.

Priming and top coating with a spirit based coating, as directed by the manufacturers, will give the highest quality finish. Where the final appearance is less important, water-based products may be used. These may cause some slight swelling of the surface wafers emphasising their outline.

Small test areas are recommended as West Fraser cannot be held responsible for other manufacturers' product claims in this respect. Manufacturers' guidelines on application should always be followed.

### Treating

If required, SterlingOSB Zero can be treated to further protect against fungal or insect attack. It is recommended that a 3-minute dip cycle rather than a double vacuum cycle be used, and a solvent-based system should be used in preference to a water-based system. Experience shows that adequate preservative

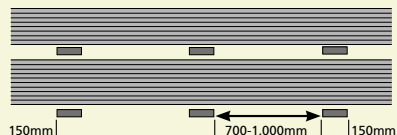

Correct method of storage on bearers

uptake is provided by this method.

Double vacuum systems and the use of water based chemicals can, as with most panel products, adversely affect the structural properties of the panel. All fire retardant impregnation systems are water based and usually involve a double vacuum and pressure cycle. It is essential to obtain structural performance characteristics from the treatment company and follow their end use recommendations. Fire-retardant paints and finishes can be used on SterlingOSB Zero. Visit [www.trada.co.uk](http://www.trada.co.uk) for up to date information.

West Fraser cannot be held responsible for any independently handled process which may affect the strength properties of the finished panel.

## SterlingOSB Zero installation advice

### Fixings

- SterlingOSB Zero should be face fixed using approx. 3mm diameter ring-shank nails or screws, 50mm long at 100mm centres across the supporting joists
- Panels must be laid with long edges at 90° to supports and short edge joints must be staggered
- All short edges must be supported on joists / studs or noggins
- Panel edges must bear approx. 18mm onto joists
- Nailing must be at least 8mm from the panel edges

- All T&G joints should be glued with a PVA adhesive
- Panels should be fixed using approx. 3mm ring-shank nails or screws whose length is 2.5 times the thickness of the panel in flooring or 50mm in roofing
- Whilst not essential, gluing of the panels to joists increases the stiffness and strength of the structure. Additionally gluing can help reduce any potential squeaks or creaks. We recommend using CaberFix Joint&Joist

### Expansion gaps

**Square edged**  
With all square edged panels, a 3mm expansion gap should be allowed between boards and edges.

**Tongue and Groove (T&G)**  
Tongue and Groove has an expansion gap included in the T&G joint. A 10mm expansion gap, or a total of 2mm per metre of boarding, (whichever is the greater), must be left at perimeters and upstands for both square edged and T&G panels.

Spans & nailing centres	Flooring		Flat Roofing			Sarking	Sarking under slates	Sheathing
	15	18	11	15	18	9	18	9
Thickness (mm)	15	18	11	15	18	9	18	9
Max. span* (domestic) (mm)	450	600	400	600	610	600	610	610
Nail centres (edges) (mm)	300	300	100	100	100	150	100	150
Nail centres (intermediate) (mm)	300	300	100	100	100	300	100	300
Weight kg/m <sup>2</sup> (approx.)	9.6	11.7	7.3	9.6	11	3.5	11	3.5
Face smooth nail retention** (N)	265	320	184	265	320	158	320	158
Edge screw retention (N)	673	647	592	673	647	–	647	–
Face screw retention (N)	833	854	692	833	854	625	854	625

\* Refer to tables on page 72 regarding UDL Limits.  
\*\* Compared to smooth nails, improved nails will improve retention performance by around 50%

## SterlingOSB Zero PrimedPlus

To achieve the optimum performance and life expectancy of the SterlingOSB Zero PrimedPlus panels, the installation guide must be closely followed. Prior to erecting the panels, ensure that the timber hoarding frame has been constructed to a suitable specification that provides adequate support for panel edges and fixings.

SterlingOSB Zero PrimedPlus boards are pre-painted with a high quality cross-linked epoxy acylate UV cured coating, then sealed with a unique wax impregnated hydroscopic edge treatment to be used immediately in any indoor or outdoor situation to provide protection from weathering and dirt ingress.

The coated board, under normal working conditions, has been designed to withstand typical exterior conditions without the need for further painting, but can be over painted if required.

- 1 Ensure panels are erected a minimum of 50mm above soil and well clear of any low-lying water.
- 2 Provide a minimum 3mm expansion gap between panels when erecting on to the timber framing (we recommend joint strips to provide extra protection).
- 3 Provide a minimum 10mm expansion gap where panels are next to walls and other solid surfaces (we recommend a joint strip to provide extra protection).
- 4 Fix panels to supporting timber framing with 50mm galvanized screws ensuring these are spaced at between 200 – 300mm centres. Ensure that screw heads finish flush with the panel surface (we recommend the use of a depth sensitive bit holder and that it is adjusted accurately).
- 5 Paint all screw heads\* using a liberal application of a quality exterior grade oil / solvent based gloss paint.  
\*If the screw heads are mistakenly driven below the panel surface, the screw holes must be filled with a quality exterior grade flexible wood filler, allowed to dry, and then painted over with oil / solvent based gloss paint.
- 6 Fix joint strips, top and bottom skirting and top capping, taking care not to damage the panel edges.

## Hoarding installation guide

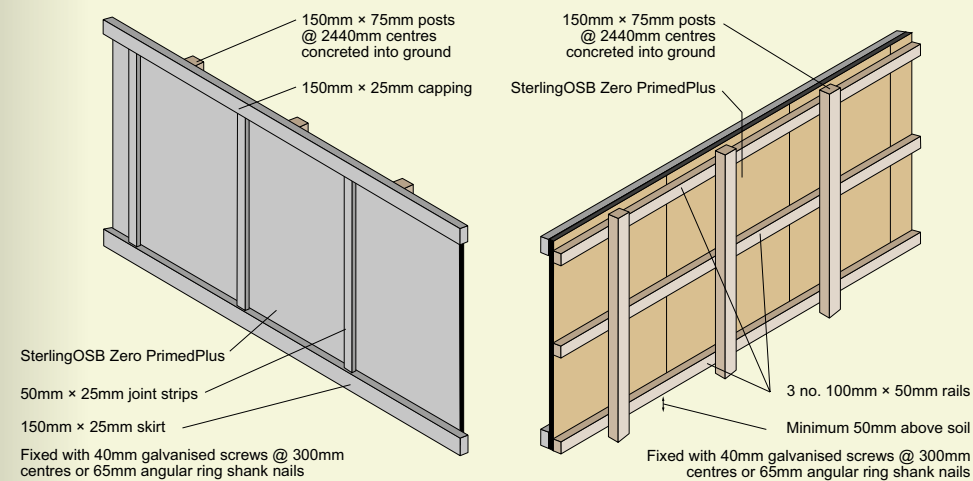

## CaberFloor technical data

### CaberFloor P5, CaberDek, CaberShieldPlus and CaberAcoustic

	Unit	18mm	22mm
Panel Weight	kg/m <sup>2</sup>	12	15
Panel Weight (2400×600mm)	kg	17.3	21.6
Density	kg/m <sup>3</sup>	660 ± 30	660 ± 30
Internal Bond strength (IB) (After cyclic test)	MPa MPa	0.45 0.22	0.40 0.2
Modulus of Rupture (MoR)	MPa	16	14
Modulus of Elasticity (MoE)	MPa	2400	2150
Moisture Content	%	5-8	5-8
Thickness Swelling 24hr immersion After cyclic test	% %	10 12	10 11
Standard Deviation of Thickness Within boards Between boards	mm mm	± 0.2 ± 0.5	± 0.2 ± 0.5
Dimensional Stability Length / Width Thickness	% %	0.25 7.0	0.25 7.0
Low Emission Grade E1 (Formaldehyde EN 120)	mg/100g	≤8.0	≤8.0
Reaction to Fire (EN 13501-1)		Class D <sub>FL</sub> -S1	Class D <sub>FL</sub> -S1

These values are typical 95%ile values when the products are tested in accordance with European Standards test methods for Particle Boards BS EN 312.

### CaberDek removable film

	Unit	Test method	Value
Film weight	g/m <sup>2</sup>	DIN 53365	70
Tensile strength MD	N/15mm	DIN EN ISO 527	55
Tensile strength CD	N/15mm	DIN EN ISO 527	45
Ultimate elongation MD	%	DIN EN ISO 527	700
Ultimate elongation CD	%	DIN EN ISO 527	500
Tear propagation strength MD	N	DIN 53363	35
Tear propagation strength CD	N	DIN 53363	30
Water Vapour Permeability (23°C/85%r.F.)	g/m <sup>2</sup> /d	DIN 53122	0.36
Temperature extremes	°C	In-house	- 40 / + 80
Puncture resistance	N	MIL STD 3010-2065	55

### Product sizes available

Product	Application	Thickness (mm)	Size (mm)	Edge profile
CaberFloor P5	Structural flooring	18, 22	2400 × 600	TG4
CaberDek	Structural flooring	18, 22	2400 × 600	TG4
CaberShieldPlus	Structural flooring	22	2400 × 600	TG4
CaberAcoustic	Overlay flooring	28, 32	2400 × 600	TG4
CaberFloor P1	Non-structural general use	12, 18	2440 × 1220	SE
CaberFloor P2/P3	Furniture & Kitchen worktops	various*	various*	SE

\* Contact our customer service team for more information



## CaberFloor storage and conditioning

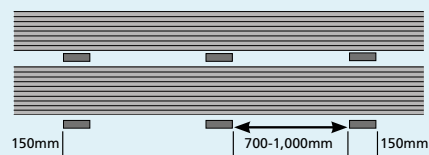

Correct method of storage on bearers

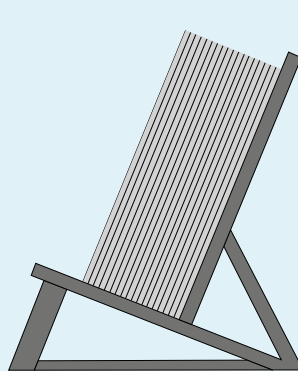

Correct method of edge stacking

### Storage

On delivery, boards should be stacked on equidistantly spaced bearers in a dry, covered area with outside storage adopted only as a last resort. If storage outside is unavoidable, stack on dry level ground and protect the boards by covering with a polythene or waterproof sheet. Ensure that the board edges are covered and secured to avoid lifting by the wind.

An HSE information sheet on the 'safe stacking of sawn material and board materials' is available in our document library at [uk.westfraser.com](http://uk.westfraser.com)

### Handling

Like all panel products, our MDF, Particleboard and OSB should be handled carefully to prevent the risk of boards slipping or toppling and potential injury.

As a duty of care to our customers, West Fraser has undertaken extensive testing of our packaging and strapping to ensure our products arrive safely.

End users are responsible to ensure that appropriate risk assessments are undertaken and safe procedures are in place.

### Conditioning

Wood particleboards expand on taking moisture from surrounding air (plus effects of wet trades, site conditions etc.) and shrink on losing it. As a guide, a small increase in moisture of 1% increases length and width by 0.25mm per metre. A decrease in moisture of 1% will have a corresponding shrinkage effect. It is clearly desirable to minimise these changes, which can be applied pro-rata, by taking a few simple precautions. Boards should be allowed to reach equilibrium by storing them under the atmospheric conditions in which they are to be used, for a minimum of 48 hours prior to laying. It is recommended that boards are loose stacked, on a minimum of 3 equi-spaced bearers, with spacers between each board to allow free air movement.

Relative humidity	Approximate equilibrium at 20°C moisture content
30%	7%
65%	11%
85%	15%

### Equilibrium moisture content

#### Moisture content

All wood is hygroscopic. Its moisture content, therefore depends on its environment. The moisture content which wood and wood-based products will attain in service (equilibrium moisture content) depends primarily on the atmospheric humidity.

Floors should be laid at a moisture content within the range likely to be encountered in service. They should also be laid after the initial drying out period is complete. It should be noted that sometimes extreme site conditions can lead to shrinkage when the building is finally occupied / heating commissioned etc. CaberFloor products are made at relatively high ex-works moisture contents compared to industry norms.

Whilst no product containing around 80% wood in its composition can be unaffected by moisture – CaberFloor P5 at ex-works (around 5-8 % moisture content) is close to the natural equilibrium moisture content of particleboards (see table) and is consequently an excellent choice.

#### Note:

*Care should be taken to ensure any joists treated with a waterborne preservative have thoroughly dried out before installation. Joist moisture content should not exceed 20%. High moisture content in the timber could lead to distortion as they dry out leading to 'creaks', particularly if the boards are not glued. Some contractors prefer to additionally bond the underside of the board to the top of the joist (using PVA adhesive).*

*Any access traps for underfloor services should be pre-planned and support provided for all sides of the traps.*

## CaberFloor installation advice

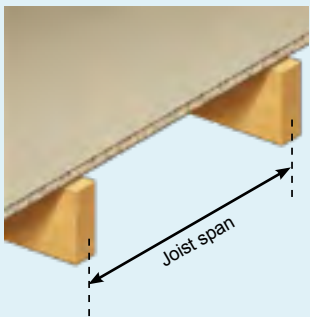

Panel thickness is dependent on joist span



T&G panels are laid with long edges across the joists

### Panel thickness

On joists up to 450mm centres use 18mm board.

On joists up to 600mm centres use 22mm board

### Tongued & Grooved panels

Tongued & Grooved panels should be laid in a staggered pattern with long edges across the joists and short edges falling on the centre of joists. Support between joists is not necessary. Should the short edges overhang then the overhang must be supported by a noggin.

Gluing T&G joints is recommended. It improves joint strength and accommodates a degree of joist variation. All joints must be glued with CaberFix adhesive (J&J, D3 or D4, dependent on panel type), otherwise, joist movement or variation may lead to movement and 'creaks'. Boards can be fixed by nailing or screwing. If nailing, annular ring shank nails should be used for fastening all edges to the joists.

If screw fixing, use a suitable pilot hole followed by Posidriv No. 8 particleboard screws, or equivalent. Fix the boards with four fixings to each short edge joint, two about 25mm from each end and two equidistant in between. All joints must be tightly butted. Length of fixings used should be 2.5 times the thickness of the board. Four equidistant fixings should be used on panel ends and three at intermediate joists.

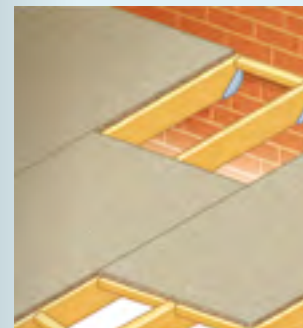

SE panels are laid with long edges in-line with the joists

### Square Edged (SE) panels

SE panels should be laid with the long edges falling on the joist centres and with the short edges supported by 38mm wide noggins with their ends secured to joists.

Nail the boards to all supports 200-300mm apart with annular ring shank nails round the edges of the board and at 300mm centres on intermediate joists. The nails used should be 2.5 times the thickness of the board. All joints must be tightly butted.



10mm minimum expansion gap should be applied to the perimeter

### Perimeter expansion gap

CaberFloor P5, when laid in a new building, will tend to absorb moisture and expand in common with other wood-based materials. It is important to leave an expansion gap of 2mm per metre run of board between the edge of the floor and the perimeter wall or any solid abutment (minimum gap 10mm). For larger areas it is necessary to incorporate intermediate expansion gaps to provide the necessary allowance for possible movements, particularly in corridor applications. Attention must be paid to maintaining expansion gaps at all times during construction.

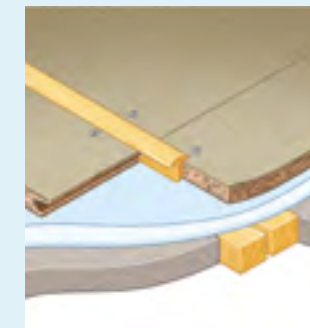

In large areas or long runs additional expansion gaps should be included

### Additional movement gaps

It is well documented and strongly recommended that additional movement gaps are incorporated in large areas or long runs e.g. corridors. BS 8201:2011 Code of practice for installation of flooring of wood and wood-based panels recommends an expansion provision of 2mm per metre run plus 1mm for every metre above 12m of the width and breadth of the floor. A simple movement provision can be made according to the diagram above and also proprietary systems are available to suit a wide range of applications.

### Important information about CaberFix D4

All professionals and industrial users of CaberFix D4 must complete training before using products containing more than 0.1% of monomeric diisocyanates - for details and training visit <https://uk.westfraser.com/safe-handling-training-for-pu-adhesives/>

## CaberFloor installation advice

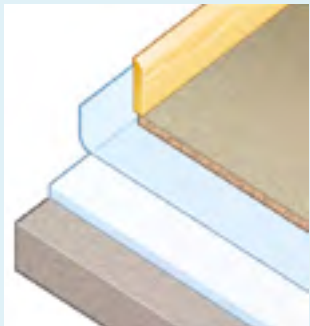

Continuously supported floating floor

### Continuously supported floating floor

It is essential that a continuous damp proof membrane – not less than 1000 gauge polythene – is used. This must be laid in accordance with CP102:1973. A continuous layer of insulation is used above the structure of pre-cast concrete beam and block.

The insulation may be incorporated in the screed. Most commonly, when used in conjunction with CaberFloor P5 as the floating floor overlay, the insulation is immediately below the flooring and laid onto the slab or beam and block, with vapour control layer between flooring and insulation. Any unevenness, localised or general, may transmit through the CaberFloor P5 layer, therefore subfloor flatness is important. The insulation material should be rigid and suitable for the loading requirements.

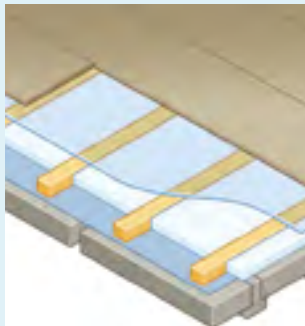

Battened floating floor

### Battened floating floors

Use additional support battens where extra floor loading is anticipated and the exact position is known, e.g. beneath kitchen equipment and sanitary fittings. When required, use a levelling screed to ensure that the battens of a timber battened system are true and level. Do not attempt to fix the flooring to the battens through resilient insulation material, as this will create an uneven floor.

If necessary lightly sand and clean floors to make the surface suitable for further overlays, e.g. thin plywood, vinyl etc. Do not wash or scrub with water.

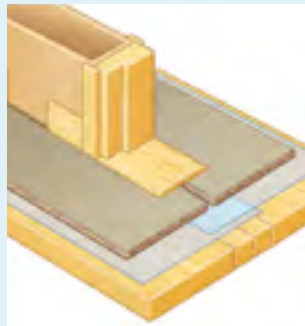

Doorway threshold

### Advice on door thresholds

At all door openings, support the edges of the panels on preservative treated timber battens. Ensure that battens are on a firm and level base and fix a strip of flooring to the battens as a threshold. Allow a gap on each side of the threshold for movement in the flooring panels.



Joisted floor

### Joisted / suspended timber floors

Joisted or suspended timber floors have an advantage in that they can accommodate the required thickness of insulation within the structure. The insulation materials may be mineral wool supported on boards (or netting) or rigid foam insulation simply supported on timber battens.

The board may be mechanically fixed to the joists and the underside of the board glued to the top of the joist for additional strength. Independent tests have shown a 10% strength increase by gluing as above. Maintain adequate cross ventilation of the subfloor space, taking care not to obstruct ventilators by insulation material or timber struts in the subfloor. Use herringbone struts in preference to solid strutting e.g. above sleeper walls.

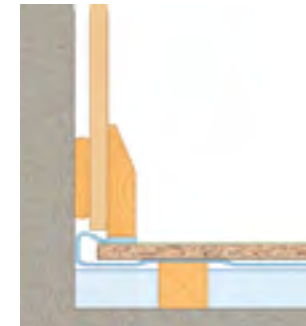

Vapour control layer with battened floor

### Advice on moisture protection

CaberFloor P5 is a highly durable product. Similar to other wood-based panels it is affected by moisture. Good practice on installation and protection against moisture in construction is advised. We recommend, with or without battens in the floating floor construction, that 1000 gauge polythene should be used as a continuous Vapour Control Layer (VCL) between the CaberFloor P5 and the insulation material.



Vapour control layer without battened floor

# CaberFloor installation advice

## T&G panel fixing methods\*

Dependent on whether gluing or mechanical fixing to joists, the following advice should be noted:

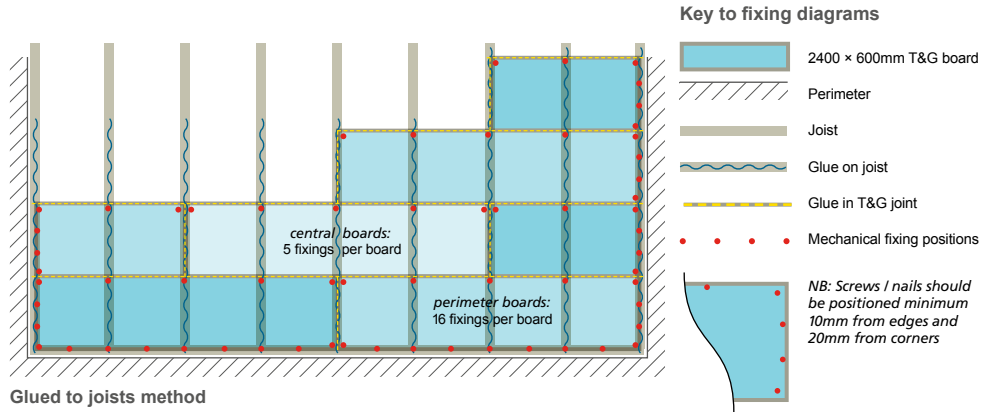

Glued to joists method

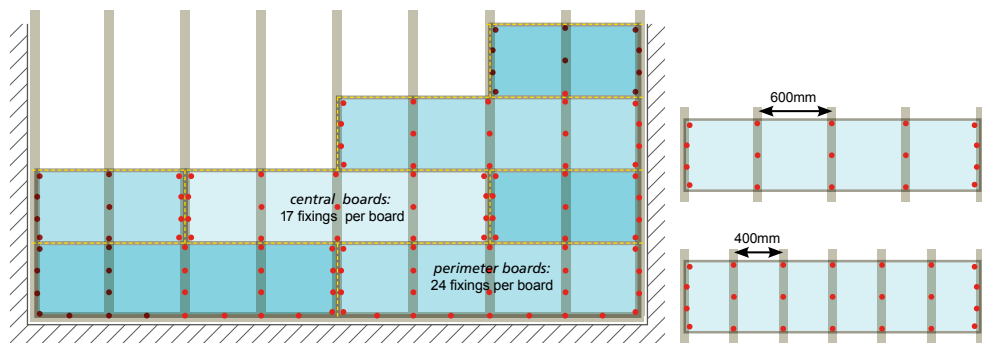

Mechanical fixing to joists method

\*Mechanical fixing methods do not apply to CaberAcoustic when used as a floating floor overlay

## Taping CaberDek

When using CaberFix Joint&Joist, for BBA approval use CaberFix Tape on all joints, perimeters and mechanical fixings.

In extreme cold conditions, CaberFix X-Treme Tape should be used instead, as it withstands cracking or lift in temperatures down to -21°C.



## Soft and resilient floor coverings

The Codes of Practice – BS 8203, WPIF floating flooring installation code of practice and BS 5325 recommends that for all overlays the subfloor must be clean, rigid and flat. When thin or shiny floor surface materials are laid over CaberFloor these materials may allow board joints to show through, particularly after trafficking. Prior to laying such materials, the CaberFloor joints should be checked for level. It is permissible to sand off any raised areas not exceeding 1mm. For raised areas greater than 1mm, additional levelling materials are required.

Thin, plain coloured carpets or vinyls or those with a high sheen – tend to show small irregularities to a greater degree. For thin vinyls and tiling, it is recommended that a plywood overlay (4mm) is fixed in position, staggering joints so as not to coincide with CaberFloor joints. The plywood should be fixed every 100mm using appropriate nails or screws around perimeter and 150mm apart elsewhere, ensuring they do not protrude above the surface. Adhesive manufacturer advice should be followed for priming of new surfaces. Usually, this involves a coat of diluted PVA emulsion.

Guidance as to construction of bases in respect to considerations and timber bases is given in BS 5385-3:2007. Tiling onto CaberFloor flooring should be undertaken only in joisted / fixed floor constructions. Noggins should be used between the joists at 300mm centres and the surface provided for tiling should be 15mm exterior grade plywood screwed to joists and noggins at 300mm centres. Existing boards can therefore be overlaid with 15mm exterior grade plywood to provide the necessary rigidity for a tiled surface. Length of fixings should be 2.5 times overall board thickness. A tile adhesive is the recommended bond material – cement / sand mortars are not recommended.

## Underfloor heating

CaberFloor flooring is suitable for use when installing hydronic underfloor heating systems.

## Acoustic performance

CaberFloor flooring can be used effectively on acoustic battened floor systems.

These systems are often used in flatted developments to achieve 'Part E' requirements of UK Building Regulations.

For more info on acoustic flooring see website.

# CaberAcoustic systems

## Acoustic performance

CaberAcoustic is a highly versatile and economical sound reducing flooring solution. Reducing both impact and airborne transmitted sounds, it can be laid over concrete and timber floors in both new and existing buildings.

- ☑ Available as 28mm or 32mm CaberAcoustic
- ☑ Reduces impact sounds transmission by  $\Delta L_w$  19dB\*
- ☑ Contributes to airborne noise reduction\*\*
- ☑ To be overlaid onto an existing deck
- ☑ Use in conjunction with flanking strip
- ☑ Made in the UK using eco recycled felt

\* 19dB sound reduction applies when CaberAcoustic is installed on its own. Greater reductions applicable (see table) when used within a system for noise transference reduction.  
 \*\* When used in the right system.

## Hush System 2003 overlay (HD1014)

<b>Impact <math>L'_{nT,w}</math> dB</b>	<b>51</b>
<b>Airborne <math>D_{nT,w}</math> dB</b>	<b>58</b>
<b>Airborne <math>D_{nT,w} + C_{tr}</math> dB</b>	<b>49</b>

Results based on the CaberAcoustic flooring being used in conjunction with all Hush joist infill and Hush ceiling components (HD1014) and installed as per both manufacturers' installation guides with all flanking paths treated. We recommend that the structure consists of a minimum 200mm joists

## Hush System MF28 overlay (HD1038)

<b>Impact <math>L'_{nT,w}</math> dB</b>	<b>51</b>
<b>Airborne <math>D_{nT,w}</math> dB</b>	<b>58</b>
<b>Airborne <math>D_{nT,w} + C_{tr}</math> dB</b>	<b>52</b>

Results based on the CaberAcoustic flooring being used in conjunction with all Hush-MF Ceiling components (HD1038) and installed as per both manufacturers' installation guides and all flanking paths treated.

## Hush overlay for masonry system (HD1018)

<b>Impact <math>L'_{nT,w}</math> dB</b>	<b>45</b>
<b>Airborne <math>D_{nT,w}</math> dB</b>	<b>62</b>
<b>Airborne <math>D_{nT,w} + C_{tr}</math> dB</b>	<b>55</b>

Results based on the CaberAcoustic flooring being used in conjunction with all Hush-MF Ceiling components (HD1018) and installed as per both manufacturers' installation guides and all flanking paths treated.

## CaberAcoustic

For use in conversion and refurbishment development in conjunction with Hush Acoustics joist infill and ceiling system (HD1014).

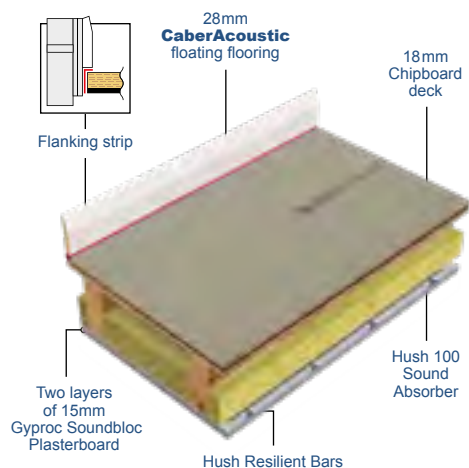

## Product data

- CaberAcoustic 28, all T&G joints to be glued using CaberFix D3 adhesive. CaberAcoustic panel to be laid over 18/22mm T&G chipboard or existing floorboards. All perimeters of the CaberAcoustic panel to be sealed using the flanking strips.
- Hush 100 Sound Absorber fitted between joists with Hush Resilient Bars screw fixed to the underside of joists at 600mm centres.
- Two layers of 15mm Soundbloc Plasterboard to be installed to the underside of the Resilient Bar. Seal all perimeters with an Acoustic Sealant prior to skimming.

## Features

- ☑ Complies to UK Building Regulations Approved Document E (England & Wales), Section 5 (Scotland) and Part G (Northern Ireland)
- ☑ A fully developed economical sound insulation system to be used to form a separating floor construction in refurbishment and conversion development with timber joists
- ☑ Provides a 1 hour fire resistance at ceiling level

## CaberAcoustic

Can be used in timber joisted floor applications in new build, conversion and refurbishment developments in conjunction with the Hush-MF Ceiling System and Hush 100 Sound Absorber (HD1038).

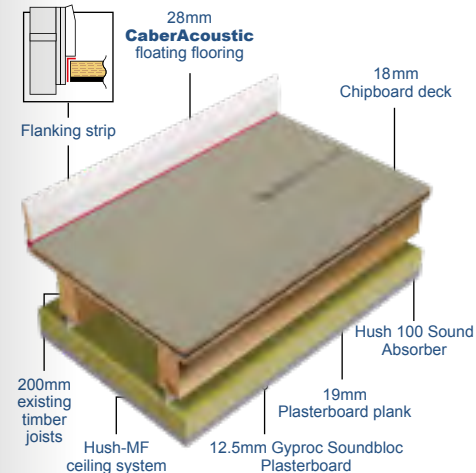

## Product data

- CaberAcoustic 28, all T&G joints glued using CaberFix D3 adhesive, laid over 18mm/22mm chipboard deck, with all perimeters sealed using a flanking strip.
- Install the Hush-MF system to the underside of the joists creating a minimum 150mm void from the underside of the joists to the back of the plasterboard lining. Install the Hush 100 Sound Absorber tightly together within the ceiling void.
- Install a double plasterboard layer to the underside of the Hush-MF system. The plasterboard lining should consist of 19mm plasterboard plank and 12.5mm Soundbloc. Seal all perimeters.

## Features

- ☑ Complies to UK Building Regulations Approved Document E (England & Wales), Section 5 (Scotland) and Part G (Northern Ireland)
- ☑ A fully developed, economical sound insulation system for use in separating floor / ceiling construction in conversion, refurbishment and new build developments
- ☑ Provides a 1 hour fire resistance at ceiling level

## CaberAcoustic

Can be used with concrete floor structures of 300-365 kg/m<sup>2</sup> in new build, conversion and refurbishment developments in conjunction with the Hush-MF Ceiling System and Hush 100 Sound Absorber (HD1018).

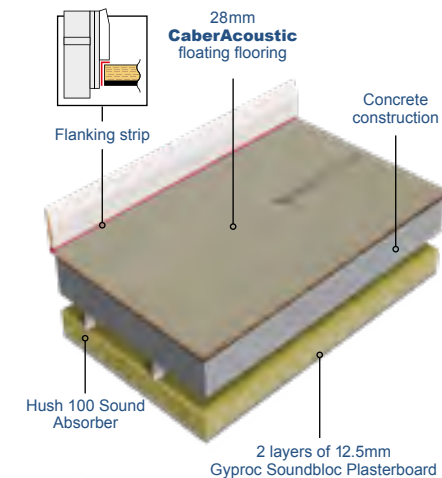

## Product data

- CaberAcoustic 28, all T&G joints glued using CaberFix D3 adhesive, with all perimeters sealed using a flanking strip, laid over 200mm in situ concrete slab.
- Install the Hush-MF Ceiling to the underside of the masonry construction. Ensure a 150mm void is created from the underside of the beam and block to the back of the plasterboard lining.
- Install the Hush 100 Sound Absorber within the Hush-MF Ceiling System.
- Install a double layer of 12.5mm Soundbloc Plasterboard to the underside of the Hush-MF Ceiling System.

## Features

- ☑ Complies with UK Building Regulations Approved Document E (England & Wales), Part G (Northern Ireland) and Section 5 (Scotland)
- ☑ A fully developed economical sound insulation system between separating floors

## CaberMDF technical data

Values are typical values in accordance with EN standards, BS EN 622-5:2009 for Fibreboards: Specification – Part 5: Requirements for dry process boards (MDF).

### Note:

Using BS EN 120.  
Thickness tolerance for all grades is:  
± 0.2mm ≤ 22mm  
± 0.3mm > 22mm  
PCP values are less than 5 ppm.

### Low emission

All CaberMDF products conform to the latest European low emission standards

### CaberMDF Trade

Property	Unit	≥4–6 mm	>6–9 mm	>9–12 mm	>12–19 mm	>19–30 mm	>30–45 mm
Thermal Conductivity 'K' Value	W/m.K			0.1	0.1	0.1	
Internal Bond (IB)	N/mm <sup>2</sup>			0.45	0.45	0.45	
Modulus of Rupture (MoR)	N/mm <sup>2</sup>			20	18	15	
Modulus of Elasticity (MoE)	N/mm <sup>2</sup>			1700	1600	1500	
Thickness Swelling (24hr immersion)	%			16	14	12	
Moisture Content [ex-plant]	%			5-7	5-7	5-7	
Reaction to Fire*	BS EN 13501:1:2007+A1:2009			D	D	D	
Formaldehyde Class	EN 13986:2004+A1:2015			E1	E1	E1	

### CaberMDF Trade MR

Property	Unit	≥4–6 mm	>6–9 mm	>9–12 mm	>12–19 mm	>19–30 mm	>30–45 mm
Thermal Conductivity 'K' Value	W/m.K			0.1	0.1	0.1	
Internal Bond (IB)	N/mm <sup>2</sup>			0.45	0.45	0.45	
Modulus of Rupture (MoR)	N/mm <sup>2</sup>			20	18	16	
Modulus of Elasticity (MoE)	N/mm <sup>2</sup>			1700	1600	1500	
Thickness Swelling (24hr immersion)	%			16	13	12	
Moisture Content [ex-plant]	%			5-7	5-7	5-7	
Reaction to Fire*	BS EN 13501:1:2007+A1:2009			D	D	D	
Formaldehyde Class	EN 13986:2004+A1:2015			E1	E1	E1	

### CaberMDF Pro

Property	Unit	≥4–6 mm	>6–9 mm	>9–12 mm	>12–19 mm	>19–30 mm	>30–45 mm
Thermal Conductivity 'K' Value	W/m.K	0.14	0.13	0.13	0.13	0.13	0.13
Internal Bond (IB)	N/mm <sup>2</sup>	0.65	0.65	0.6	0.55	0.55	0.5
Modulus of Rupture (MoR)	N/mm <sup>2</sup>	23	23	22	20	18	17
Modulus of Elasticity (MoE)	N/mm <sup>2</sup>	2700	2700	2500	2200	2100	1800
Thickness Swelling (24hr immersion)	%	30	17	15	12	10	8
Moisture Content [ex-plant]	%	5-7	5-7	5-7	5-7	5-7	5-7
Reaction to Fire*	BS EN 13501:1:2007+A1:2009	D	D	D	D	D	D
Formaldehyde Class	EN13986:2004+A1:2015	E1	E1	E1	E1	E1	E1

### CaberMDF Pro MR

Property	Unit	≥4–6 mm	>6–9 mm	>9–12 mm	>12–19 mm	>19–30 mm	>30–45 mm
Thermal Conductivity 'K' Value	W/m.K	0.14	0.13	0.13	0.13	0.13	0.13
Internal Bond (IB)	N/mm <sup>2</sup>	0.7	0.8	0.8	0.75	0.75	0.7
Modulus of Rupture (MoR)	N/mm <sup>2</sup>	27	27	26	24	22	17
Modulus of Elasticity (MoE)	N/mm <sup>2</sup>	2700	2700	2500	2400	2300	2200
Thickness Swelling (24hr immersion)	%	18	12	10	8	7	7
Moisture Content [ex-plant]	%		5-7	5-7	5-7	5-7	5-7
Reaction to Fire*	BS EN 13501:1:2007+A1:2009		D	D	D	D	D
Formaldehyde Class	EN 13986:2004+A1:2015		E1	E1	E1	E1	E1

### CaberMDF Industrial

Property	Unit	≥4–6 mm	>6–9 mm	>9–12 mm	>12–19 mm	>19–30 mm	>30–45 mm
Thermal Conductivity 'K' Value	W/m.K			0.13	0.13	0.13	
Internal Bond (IB)	N/mm <sup>2</sup>			0.9	0.9	0.9	
Modulus of Rupture (MoR)	N/mm <sup>2</sup>			26	24	22	
Modulus of Elasticity (MoE)	N/mm <sup>2</sup>			2500	2400	2300	
Thickness Swelling (24hr immersion)	%			10	8	7	
Moisture Content [ex-plant]	%			5-7	5-7	5-7	
Reaction to Fire*	BS EN 13501:1:2007+A1:2009			D	D	D	
Formaldehyde Class	EN 13986:2004+A1:2015			E1	E1	E1	

\*Refer to EN13986:2004+A1:2015, Table 8, for End Use Classifications

## CaberMDF storage and conditioning



### CaberMDF panel weight guide

For lifting & handling purposes using an 18mm panel thickness, the following should be used as a guide weight (kg per m<sup>2</sup>).

- CaberMDF Trade / MR      10 kg/m<sup>2</sup>
- CaberMDF Pro / MR      13 kg/m<sup>2</sup>
- CaberMDF Industrial      14.5 kg/m<sup>2</sup>

*Note: Calculations for guide weights for thicknesses other than 18mm, are pro-rata, e.g. 12mm CaberMDF Trade = 10 kg/m<sup>2</sup> x 12/18 = 6.7 kg/m<sup>2</sup>.*

### Transport and storage

CaberMDF should be:

- Transported in uniform stacks on a flat base to avoid damage
- Protected against the weather
- Stored on a rigid flat base and adequately ventilated
- Insulated from the ground to avoid dampness

When wooden bearers are used, they should be of uniform thickness and placed in line. The distance between bearers should be no greater than 700–1,000mm.

An HSE information sheet on the 'safe stacking of sawn material and board materials' is available on request.

### Conditioning

Wood panel products expand on taking moisture from surrounding air and shrink on losing it. As a guide, a small increase in moisture of 1% increases length and width by 0.25mm per metre. A decrease in moisture of 1% will have a corresponding shrinkage effect.

It is clearly desirable to minimise these changes, which can be applied pro-rata, by taking a few simple precautions. Boards should be allowed to reach equilibrium by storing them under the atmospheric conditions in which they are to be used, for a minimum of 48 hours prior to laying. It is recommended that boards are loose stacked, on a minimum of 3 equi-spaced bearers, with spacers between each board to allow free air movement.

### Moisture content

All wood is hygroscopic. Its moisture content, therefore depends on its environment.

The moisture content which wood and wood-based products will attain in service (equilibrium moisture content) depends primarily on the atmospheric humidity.

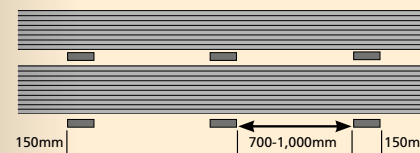

Correct method of storage on bearers

Relative humidity	Approximate equilibrium at 20°C moisture content
30%	7%
65%	11%
85%	15%

## CaberMDF machining advice

CaberMDF has a consistent density and a smooth surface that is ideal for machining, profiling, painting, or the application of paper foils and veneers. In many respects, CaberMDF can be treated as a high quality timber, but without the inherent defects of knots and grains.



**Profiled edges require no edge banding or lipping**

### Machining

CaberMDF is a homogeneous wood fibre material, ideally suited to modern machine tooling.

CaberMDF can be worked easily with all conventional woodworking machines. It saws cleanly and drills easily. It also shapes and routs exceptionally well, without splintering or chipping. CaberMDF is equally suited for use with most hand tools.

### Profiling

Profiled edges require no edge banding or lipping. Sculptured or textured effects can be machined or embossed, and narrow or small door frames can be produced from a single piece of board.

A major advantage of CaberMDF is the relative ease of finishing perpendicular and moulded edges without the need for elaborate filling or the application of adhesive bonded edging materials. This characteristic derives from the uniform density of CaberMDF, and the absence of core voids which would require filling.



**Sanding after moulding or routing produces a much smoother finish.**

### Sanding

Sanding after moulding or routing produces a much smoother finish. The moulded edges can be sanded with any number of different profile sanders. Various polyurethane based abrasive wheels are available to fit to spindle moulders or in line with a double end tenoner. These wheels can be shaped to the cutter profile using an abrasive paper glued to the desired edge profile.

80/100 grit should be used for the removal of cutter marks. 120/150 grit is usually used for finish sanding with finer grades available, if required.

### Sawing

Follow these tips to ensure best results, minimum breakout and a longer tool life:

- Tungsten carbide saws are recommended for general use
- Saw blades should have higher clearance angles and increased tool angles compared with normal woodworking saws
- Clearance angles should be maintained when the saw is serviced. Reduced angles will increase the amount of resin build up. Increased angles will increase the life between sharpening
- Chipload – which is the thickness of chip cut by each tooth - should be in the range of 0.15 to 0.25mm. The feed rate required to produce this is calculated as follows

$$\text{Feed rate (mm/min)} = \text{Chipload} \times \text{r.p.m.} \times \text{no. of teeth}$$

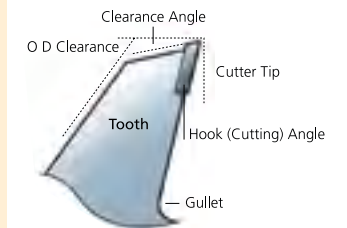
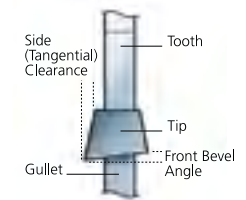
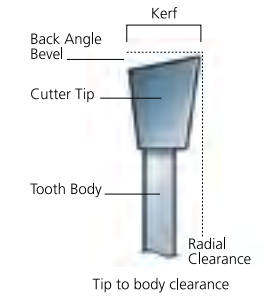

**Saw blades and tools should have increased clearance angles to reduce resin build up and increase the life between sharpening.**



## CaberMDF fixing advice

### Mechanical joints and fixings

Mechanical fittings developed for use with particleboard can be applied to MDF with the following recommendations:

- Wherever possible select fittings that depend upon face fixing
- Avoid fittings which depend upon the expansion of a component inserted into the board edge
- When using screws follow the pilot hole dimensions recommended below

### Screwing

The internal bond strength of CaberMDF gives substantially better screw holding over other types of panel products.

#### Type of screw

Most types of screw can be used. Best results are obtained with parallel thread screws. A high overall diameter to core ratio is desirable.

#### Positioning

Screws which are inserted into the face should not be less than 25mm from the corners. Screws inserted into the edge should not be less than 70mm from the corners. Do not over tighten screws as further turning after screws are tight will reduce the holding power.

#### Pilot holes

Larger diameter pilot holes than those recommended for solid wood and particleboard are required in faces and edges of MDF to accommodate the core of the screw. For GKN Superscrews the recommended pilot diameter should be 85% to 95% of the screw core diameter.

This requirement is particularly important when screwing into the edges of thinner boards. Pilot holes should be drilled approximately 1mm beyond the expected depth of insertion of the screws into the board.



Use screws with the non threaded core of a similar length to the thickness of the panel being jointed.

Use screws with parallel thread rather than traditional thread.

Parallel thread      Traditional thread

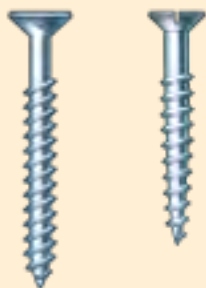

### Dowel joints

Dowel holes should be machined with a sharp tool so that the surfaces are free from loose fibre. All dust should be removed prior to assembly. The dowel hole diameter should be slightly larger than the dowel. This will allow good adhesive cover and avoid splitting of the edge.

Dowels with multiple longitudinal or spiral groove patterns ensure uniform adhesive spread within the joint. For best results dowels should be given a total glue coverage. Adhesives such as Polyvinyl Acetate (PVA) or Urea Formaldehyde are preferred as they have good gap filling properties, and their high solid content counteracts absorption of adhesive into the machined edges of CaberMDF.



Dowel with 1mm all round clearance preferred.

Smooth dowels are not recommended, grooved dowels are preferred.



### Nailing and stapling

Where other methods of fixing are not practical, CaberMDF can be fixed with nails. Nails should be spaced 150mm apart to reduce the risk of splitting and at least 70mm from the corners. Nailing the edges of 9mm and 12mm CaberMDF is not recommended because of the risk of splitting.

CaberMDF can also be fixed using staples. For best results staples should not be inserted closer than 12mm from the edges and 25mm from the corners. This fixing method is only recommended for applications involving light loads. Close spacing of the staples is acceptable but the legs should be aligned at an angle of 15° to the plane of the board.

## CaberMDF fixing advice *continued*



Mitre joints between CaberMDF panels

### Adhesive bonded joints

A wide variety of jointing methods can be adopted providing the following simple guidelines are observed:

- The joint parts should be accurately machined
- Sharp cutters should be used to avoid tearing or burnishing the surfaces to be bonded
- A high solids content adhesive with gap filling properties should be used. (Polyvinyl Acetate or Urea Formaldehyde)
- Mating pieces should be accurately located and held under pressure while the adhesive is setting
- The width of grooves machined in CaberMDF should be limited to about one third of the thickness of the board
- The depth of groove should be about one half of the board thickness
- Adhesive bonded joints should be allowed to condition for several days before sanding and finishing to avoid the appearance of sunken joints. This treatment is essential when using high gloss finishes
- A tongue and groove joint is very efficient, provided the fit of the joints is not too tight as this may cause a split along the edge
- When attaching lippings the tongue should be machined on the solid wood piece

### Wall panels

CaberMDF can be fixed using conventional dry lining techniques. For best results, follow these recommendations:

- Before fixing, condition the board for a minimum of 24 hours in the area of use
- An expansion gap of 10mm or 2.5mm per metre (whichever is the greater) must be allowed, on length and width
- Gaps are normally left as 'feature gaps', or they may be concealed by a suitable cover strip
- Provision should be made to ventilate the side fixed to battens
- Fix boards to supports with screws as specified at 200mm intervals, 25mm from edges. Screw length should be 2.5 times board thickness. Use 400mm centres for boards of less than 12mm

## CaberMDF finishing advice

### Laminating

#### Paper foils

The smooth, stable surface of CaberMDF makes it an ideal substrate for surfacing with decorative paper.

Flat platen presses developed for wood veneering are normally used for bonding heavier weight foils (80g/m<sup>2</sup> and higher). Short cycle platen presses and hot roller laminators are normally used for medium and lightweight foils. Adhesive coating weights in the range 80-100g/m<sup>2</sup> are typical for heavyweight foils and 60-80g/m<sup>2</sup> for medium and lightweight foils.

#### PVC foils

PVC foils are normally bonded at room temperature in a roller laminator using copolymer dispersions or epoxy adhesives. The panels emerging from the press should be stacked on a flat base for several hours to allow the bond to achieve full strength before further processing.

#### Heat transfer foil

Heat transfer foil can be applied to CaberMDF by a simple one-step drying process. When wood grain foil has been applied to a surface, a coat of lacquer can be applied by conventional methods to provide additional protection.

#### Resin impregnated papers

Melamine resin impregnated papers can be laminated to MDF by following the same procedures adopted for melamine-faced particleboard.

#### Wood veneering

CaberMDF's smooth surface provides a suitable substrate for the application of wood veneer using Urea Formaldehyde (UF) or cross linked Polyvinyl Acetate (PVA) adhesives as the bonding agent. The close thickness tolerance on CaberMDF ensures uniformity of pressure over all panels in a press load.

Facing and backing veneers must have approximately equal thickness and moisture content to ensure flatness. Wood veneered CaberMDF panels should be stacked flat and allowed to cool for a minimum of eight hours before further processing.

#### Choice of adhesive

CaberMDF can be joined with excellent results with most commercial brands of adhesives available to the furniture and joinery Industries. The choice of a specific type of adhesive will be determined by the surface characteristics of the other materials being bonded to the MDF. Consult your individual adhesive suppliers for more detailed specific information.

Adhesive data	Polyvinyl Acetate	Urea Formaldehyde	Neoprene	Copolymer Dispersion	Epoxide	Hot Melt	Polyurethane Solvent Based	PMDI
Wood veneering	•	•			•	•		
Plastic laminate veneering	•	•	•		•			
Paper foil laminating		•		•				
PVC foil laminating				•	•			•
Edge lipping or banding	•	•			•	•		
Assembly jointing	•	•			•	•		
Veneer foil wrapping	•					•	•	

## CaberMDF finishing advice *continued*

### Sealing and painting

The smooth surface of CaberMDF makes it suitable for successful finishing with a wide range of coatings.

Alternatively, the natural appearance of the MDF surface can be enhanced using a transparent stain with a clear lacquer topcoat. High gloss or matt finishes can be achieved. The selection of the finishing system, on the basis of chemical type, will depend on the scale of production, application equipment, drying facilities and the expected performance of the finish in relation to the conditions of use. Modern combined systems are possible, e.g. UV sealers, basecoats / AC (acid catalysed) topcoat.

The surfaces to be finished should be free from dust or sanding marks. CaberMDF is suitable for most matt finishing treatments without further sanding. An additional light sanding with 180/220 grit is recommended when using high gloss finishes or where a minimum coating thickness is required. High absorption of lacquer or paint into the machined edges of MDF can be prevented by the application of an appropriate sealer such as shellac, polyurethane diluted polyvinyl acetate (PVA) or specially formulated high solids sealers based on two-component catalysed resins. Edge sealing is recommended. The sealed edges can be stained if required, and then finished with one or two coats of clear or tinted lacquer to match the finish on the surface.

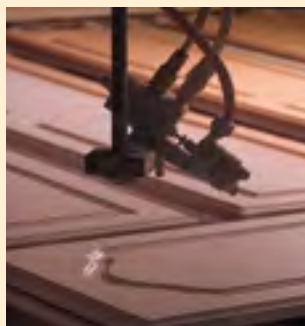

For information and advice on suitability of paints and lacquers contact the following:

#### FIRA

Furniture Industry Research Association  
www.fira.co.uk

#### SDF

Scottish Decorators Federation  
www.scottishdecorators.co.uk

#### PDA

Painting and Decorating Association  
www.paintingdecoratingassociation.co.uk

## PRODUCT SAMPLES

We want to ensure you've got the right product for the job, so offer free samples of each of our products. A5 in size, they're individually labelled and wrapped in an informative cover.

To request free samples, visit: [uk.westfraser.com/samples](http://uk.westfraser.com/samples)



# COMMITTED TO THE ENVIRONMENT

We are committed to sourcing all our timber from well-managed, FSC®-certified forests and other controlled sources.



The mark of  
responsible forestry

## Forest Stewardship Council®

The FSC® product label allows consumers worldwide to recognise products that support the growth of responsible forest management. In an increasingly environmentally aware marketplace many demand the FSC® mark on their wood products – with West Fraser it comes as standard.

At West Fraser, all of our UK and European facilities are regularly visited by a team of environmental auditors, so there is always something better to strive for and a new standard to set. West Fraser is a name you can trust to deliver, and to keep its promises.



## Net carbon negative

Here in the UK our products have been certified as net carbon negative. We lock up more carbon than we emit: 1.18 million tonnes of CO<sub>2</sub>e per year. Our engineered wood panel products help UK construction comply with net zero targets.

Find out more at uk:  
[uk.westfraser.com/carbon-negative](http://uk.westfraser.com/carbon-negative)

## Investing in the environment

In the UK, West Fraser has invested heavily in environmental improvements since 1995. This includes air cleaning technology such as state-of-the-art WESPS (wet electrostatic precipitators). It also means investment in recycling facilities. We can generate as much as half our mills' energy needs by using wood residues as fuel – composting what is left.

By reusing and conserving, we safeguard the environment and keep our costs down. In turn, our products are good for the environment and also good for your budget.

All of our UK mills have obtained the coveted environmental ISO 14001 accreditation. The ISO 14000 family addresses environmental management. This details what the organisation does to:

- Minimise harmful effects on the environment caused by its activities
- Achieve continual improvement of its environmental performance



## YOUR CUSTOMER SUPPORT TEAM

Our team are here to help - whatever your need or question, we're at the end of the phone.

### Business Development Team

Dedicated to helping our customers increase their sales of our product range.

Whether it be a joint approach to business development, or fulfilling your training needs, our team of Business Development Managers are available to help you.

Please see our website for your local contact.

[uk.westfraser.com/about-us/uk-sales-team](https://www.uk.westfraser.com/about-us/uk-sales-team)

### Customer Service Team

Based at our head office near Stirling, Scotland, our team can help you with any questions you might have about availability, deliveries, pricing queries, or anything else you can think of.

Orders should be placed directly via email to: [salesorders@westfraser.com](mailto:salesorders@westfraser.com)

Our Internal Sales Team are available via the sales phone line: 01786 819 225

### Contact

For general enquiries, technical support or advice on West Fraser products please contact us.

General enquiries:

T: 01786 819 225

Technical advice:

**SterlingOSB Zero**

T: 01463 792 424

**CaberFloor  
CaberMDF**

T: 01786 819 449

Accounts:

T: 01786 819 214

For more information on any of our products  
and technical documentation:

**[uk.westfraser.com](http://uk.westfraser.com)**

General enquiries:

T: **01786 819 225**

Technical advice:

**SterlingOSB Zero**

T: **01463 792 424**

**CaberFloor**

**CaberMDF**

T: **01786 819 449**

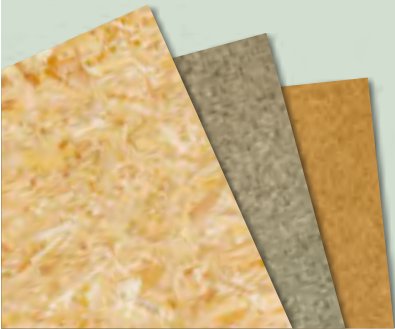

To request free samples, visit:  
**[uk.westfraser.com/samples](http://uk.westfraser.com/samples)**

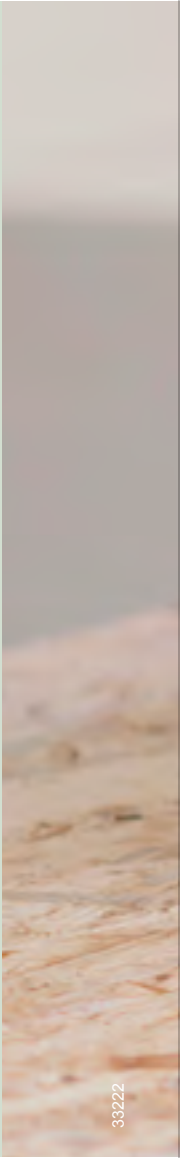

33222

**West Fraser.**  
Station Road, Cowie,  
Scotland, FK7 7BQ